

EINBAUANLEITUNG “Türkorb“ & „Regalkorb“

- Ⓜ GB Assembly manual „door basket“ & „shelf basket
- Ⓜ FR Notice de montage du bac étagère et du bac pour porte
- Ⓜ NL Opbouwbeschrijving „ Deurrek & Wandrek
- Ⓜ ES Instrucciones de instalación „Cesta para puerta“ y „Cesta para estantería“
- Ⓜ IT Istruzioni per l'installazione „Cestello per porta“ e „Cestello per parete“
- Ⓜ DK Installationsvejledning til „StyleBox“ fast møbelhjul
- Ⓜ SE Monteringsanvisningar „Dörrkorgar“ & „Hyllkorgar“
- Ⓜ NO Monteringsanvisning „Dørkurver“ og „Hyllekurver“
- Ⓜ PL Instrukcja montażu Koszyk
- Ⓜ SK Pokyny na inštaláciu „koša vo dverách“ a „policového koša“
- Ⓜ SI Priročnik za montažo „košare za vrata“ in „košare za police“
- Ⓜ CZ Pokyny k instalaci „koše ve dveřích“ a „policového koše“
- Ⓜ HU Szerelési útmutató „Ajtókosár“ & „Polckosár“
- Ⓜ HR Upute za ugradnju „Košare za vrata“ i „Košare za police“

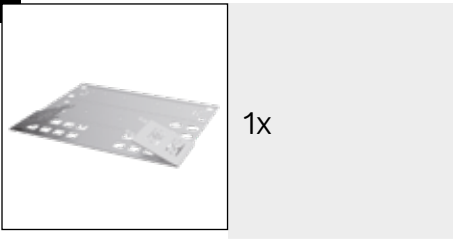

1.



1.

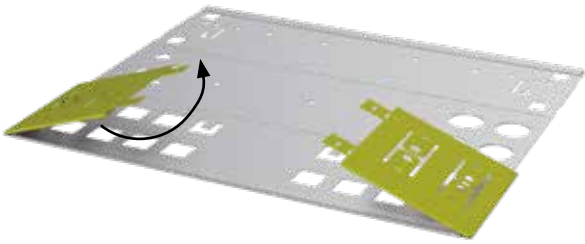

2.

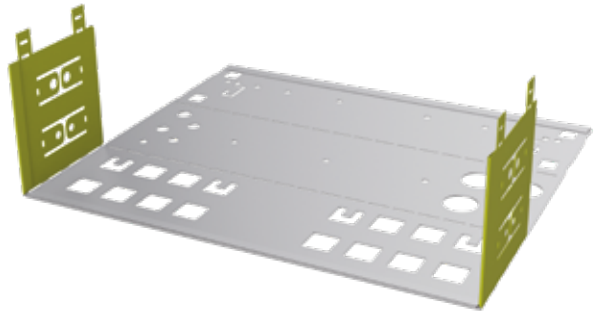

2.

1.

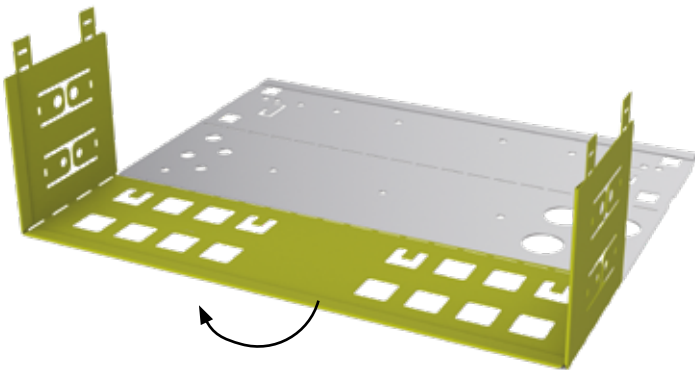

2.

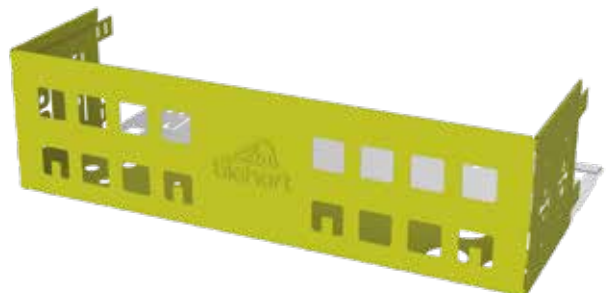

3.

1.

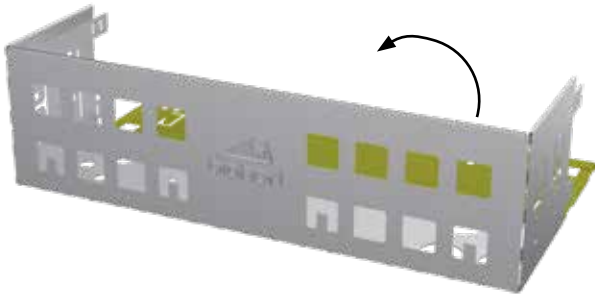

2.



4.

1.

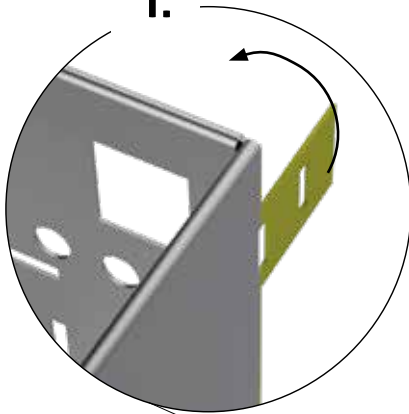

2.

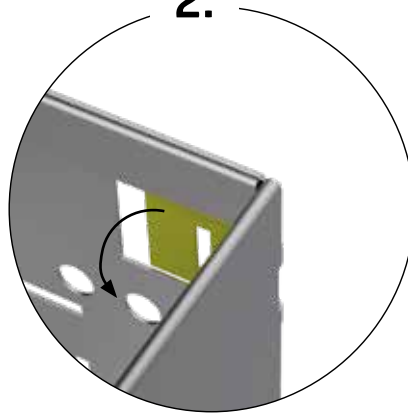

3.

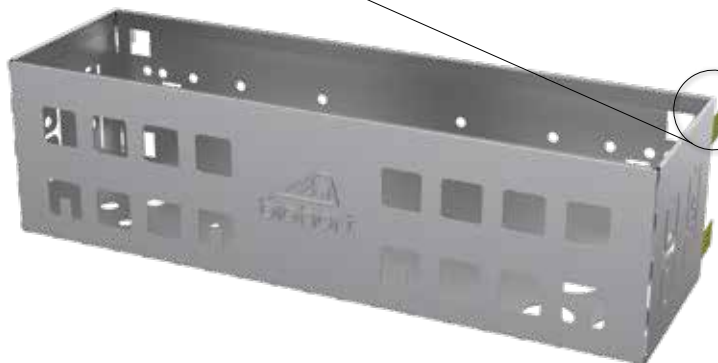
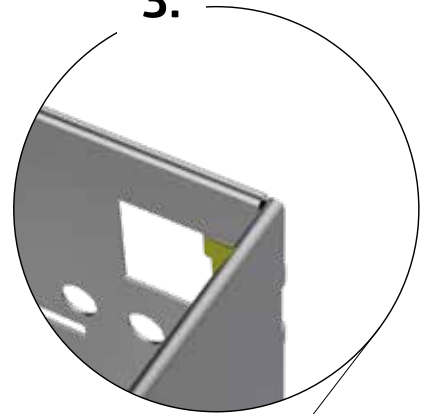



HIGHLINE



AVANTGARDE



PANORAMA



NEO

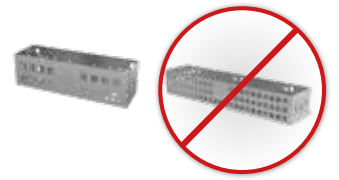

2x



M5 x 10

4x

1.



2.

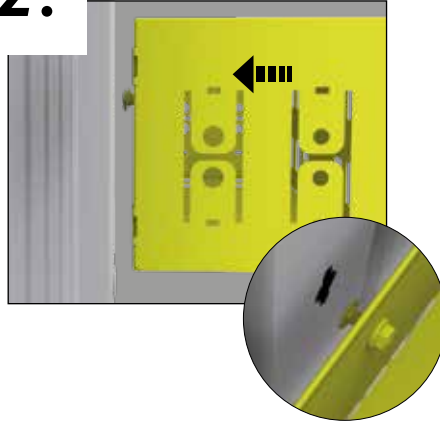

3.

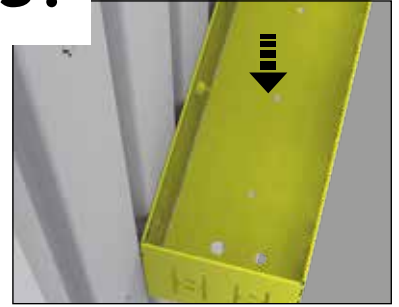



EUROPA



GERÄTESCHRANK



2x



M5 x 10

4x

1.



2.

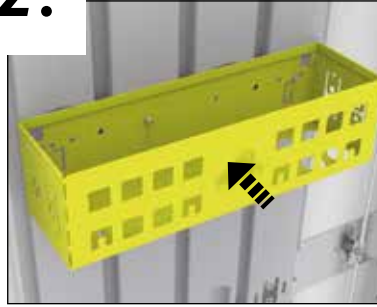

3.





NEO



2x

1.

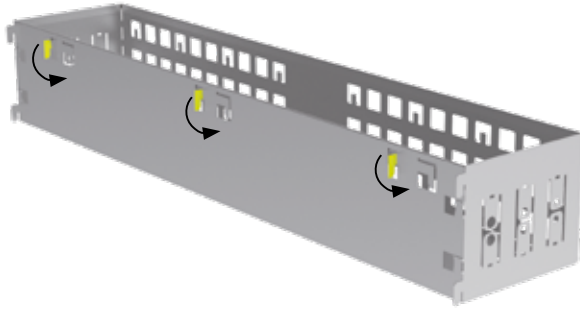

2.

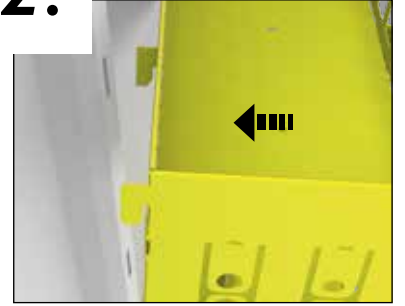

3.

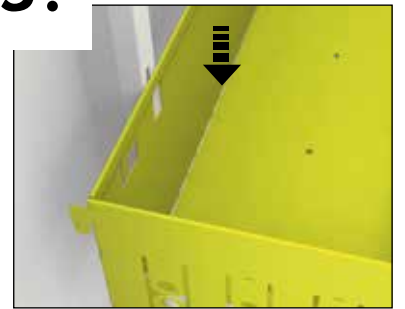



HIGHLINE



AVANTGARDE



PANORAMA



EUROPA



GERÄTESCHRANK



2x



2x



4x



1.



2.

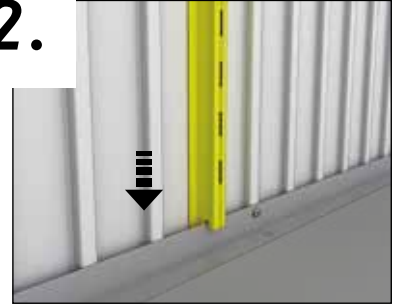

3.



4.



5.

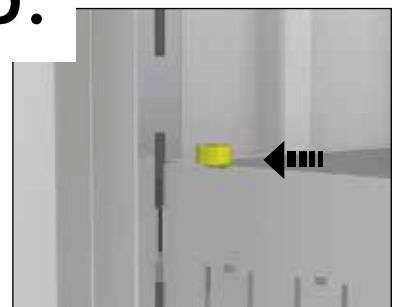



GERÄTEHÄUSER – Setzen Sie auf Qualität & Langlebigkeit
GARDEN SHEDS – rely on quality & longevity



GARTENBOXEN – Outdoorboxen für Garten, Terrasse & Co.
OUTDOOR BOXES – outdoor boxes for garden, patio & more



FAHRRAD-GARAGEN – Fahrräder, Roller & Co sicher verstaut
BICYCLE STORAGE – for safe storage of bicycles, scooters & more



MÜLLTONNEN-BOXEN – Stylish, praktisch & wartungsfrei
DUSTBIN STORAGE – stylish, practical & maintenance free



GARTEN-HELFER – Gartendesign in Bestform
GARDENING HELPERS – garden design at its best

Kontrollnummer:
 Control-number / Contrôle-Qualité / Controlnummer:



Bei Reklamationen bitte anführen:
 Kontrollnummer und Artikelnummer des reklamierten Teils.

GB: In case of complaint please indicate the control-number and the number of the item, which is subject of complaint.

F: Pour toutes réclamations: prière de joindre le numéro de contrôle et le numéro d'article de la pièce litigieuse.

NL: Bij reclamaties svp doorgeven: controlnummer en artikelnummer van het desbetreffende onderdeel.



Biohort steht für
 „LEBEN IM GARTEN“

Biohort stands for
 „LIFE IN THE GARDEN“

follow us:

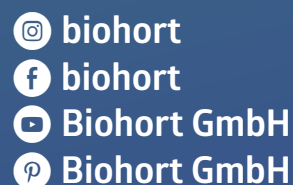

Biohort GmbH
 Pürnstein 43, 4120 Neufelden, Österreich
 Tel: +43-7282-7788-0
 E-Mail: office@biohort.at, www.biohort.com