

JUMPKING[®]

Trampolines

User Guide

Made In China

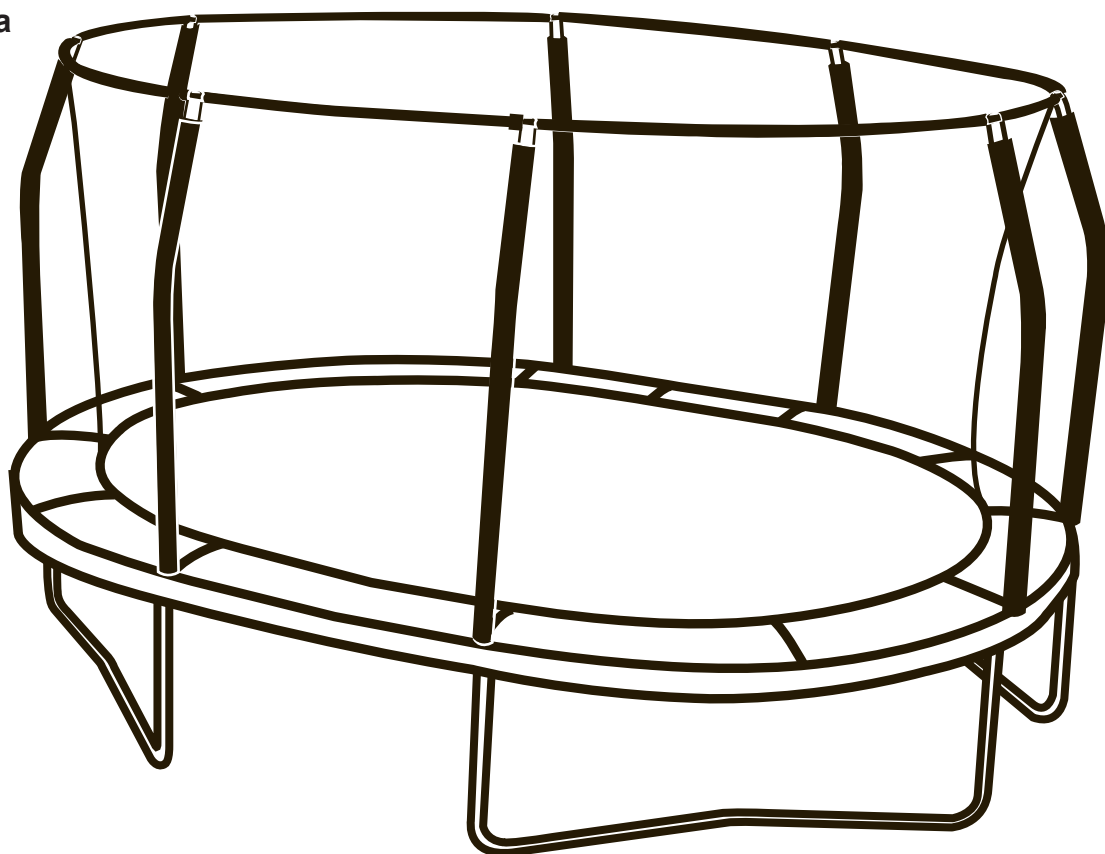

14ft x 17ft JumpPOD Oval

Got a Problem building your trampoline?
Call us on 0344 800 4060 and we can help

Patent no: DE602006006495D1, EP1721640B1 and US7628731



WARNING: Read these assembly instructions carefully before attempting to assemble or use this product. Keep this user guide in a safe place for future reference.

IMPORTANT INFORMATION

- . WARNING! ADULT SUPERVISION & GUIDANCE REQUIRED AT ALL TIMES.
- . Recommended age 6+ years.
- . No somersaults or flips - can cause serious injury.

WARNINGS!

- . Only for domestic use.
- . Maximum user weight limit 120 kg.
- . Not suitable for children under 36 months - small parts, choking hazard.
- . Outdoor use only.
- . The trampoline should be assembled by an adult in accordance with assembly instructions and checked in every instance before use.
- . Only one user. Collision hazard.
- . Always close the net opening before jumping.
- . Remove footwear before jumping on the trampoline.
- . Do not use the mat / jumping bed when it is wet.
- . Empty pockets and hands before jumping.
- . Always jump in the middle off the mat / jumping bed.
- . Do not eat whilst jumping.
- . Do not exit by a jump.
- . Limit the time of continuous usage (make regular stops).
- . Do not use in strong wind conditions and secure the trampoline.
- . The net should be changed every 1 year.

ADVISORY

- . This trampoline is not intended to be buried in the ground.
- . The following product dimension relate to this 14ft x 17ft Oval trampoline:
 - Height from ground to top rail: 89cm (0.89m)
 - Height from ground to top of enclosure: 281cm (2.81m)
 - Height from top rail to top of enclosure: 192cm (1.92m)
- . The trampoline must be placed on a level surface at least 2m from any structures or obstructions such as fence, garage, house, overhanging branches, laundry lines or electrical wires.
- . Do not install the trampoline over concrete, asphalt or any other hard surface not at proximity of other conflicting installation, such as paddling / swimming pools, swings, slides or climbing frames.
- . Inspect trampoline / enclosure net before each use. Any damaged or worn parts must be replaced before using the trampoline (see spare parts page 9).
- . If an access ladder is used it should be removed when trampoline is not in use.
- . Make sure there are no children / animals / obstructions underneath the trampoline.
- . Access the trampoline through the door of the enclosure net only. Making sure you securely close it before bouncing.
- . Please don't use when it's windy or rainy as this can cause you slip and become injured.
- . Don't intentionally rebound off the enclosure net as this will weaken it.
- . Only attach manufacturer approved accessories to the trampoline and enclosure net.
- . Always jump in the middle of the mat and practice bounce techniques safety with adult supervision and guidance.
- . Jump without shoes.
- . In certain countries during winter period, the snow load and the very low temperature can damage the trampoline. It is recommended to remove the snow and store the mat and the enclosure indoor.

IMPORTANT PRECAUTIONS



- Do not land on your head or neck.
- Paralysis or death can result, even if you land in the middle of the jumping surface.
- To reduce the chance of landing on your head or neck, do not do somersaults (flips).
- Avoid bouncing when tired.



- Only **1 user** allowed at any one time.
- Multiple jumpers increase the chances of loss of control, collision and falling off. This can result in serious injury to head, neck, arms or legs.

JUMPING INSTRUCTIONS

Fundamental Bounce

1. Start from a standing position with your head erect and your eyes on the frame pad.
2. Swing your arms forward and up in a circular motion.
3. Bring your feet together and point your toes downward while in the air.
4. Keep your feet about 30 cm (15 in.) apart from when landing on the bed.

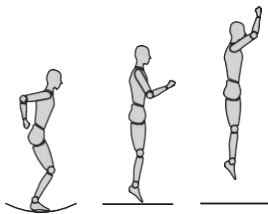

Knee Drop

1. Start bouncing from a standing position, keeping your eyes on the frame pad.
2. Land on your knees, keeping your back straight and your body erect.
3. Come back up to an erect position.

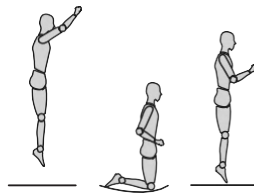

Hand and Knee Drop

1. Start bouncing from a standing position, keeping your eyes on the frame pad.
2. Land on the bed on your hands and knees.
3. Push with your hands and come back up to an erect position.

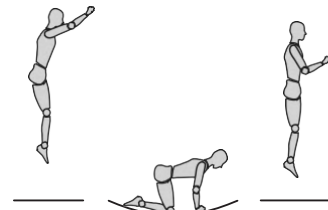

Seat Drop

1. Land in a sitting position with your legs parallel to the bed.
2. Place your hands on the bed beside your hips.
3. Push with your hands to return to an erect position.

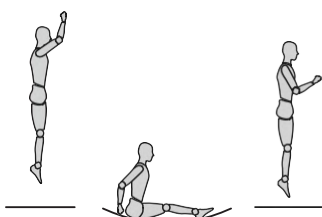

HalfTurntable

1. Start from the front drop position and push to the left or right with your arms to begin turning your body in the opposite direction.
2. Turn your head and shoulders toward the direction that your body is turning.
3. Keep your back parallel to the bed and your head up.
4. After completing a half turn, land in the front drop position.

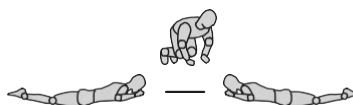

Swivel Hips

1. Start with a seat drop.
2. Turn your head to the left or right and swing your arms up in the same direction.
3. Turn your hips in the same direction as your head and arms, completing a twist.
4. Land in the seat drop position.

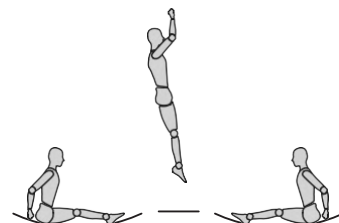

CARE & MAINTENANCE

Regular care and maintenance of your trampoline is required. This will help prolong its life and reduce the possibility of injury. Neglecting this can lead to a risk for users.

Inspect your trampoline before each use using the checklist below as a guide. Take particular care in doing this at the start of each season and at regular intervals. Ensure all parts are intact and cannot become dislodged during play, tighten any screws or nuts and bolts where required.

IMPORTANT: If any faults are found, the trampoline **MUST NOT BE USED**. We advise that the trampoline is dismantled and placed in a dry place until new parts are fitted.

PART	CHECKLIST	OK	NOT OK
All Parts	Securely attached		
	Correctly positioned		
	No sharp edges or points present		
	No missing parts		
Springs	No damage (<i>bent / broken</i>)		
	No missing parts		
Frame / Enclosure Poles	No bent parts		
	No damage		
	No rusting or corrosion		
Bed / Enclosure Net / Frame Pad / Foam Tubes	No missing parts (e.g. V-rings / Ties / Zips etc.)		
	No sagging		
	No damage (Holes / Rips / Fraying / Tearing)		

Looking after your trampoline:

- Use trampoline as advised on pages 2-3. Excess weight and improper use of the trampoline will damage it and cause it to break easily.
- Keep trampoline clean. If any part becomes dirty, clean with a damp cloth and dry thoroughly. Do not use any abrasive cleaners as this could damage the product.
- Store enclosure net and frame pad in a dry place when not in use. Prolonged exposure to sun and harsh weather can shorten its life.
- Keep bed in good condition by protecting it with a cover (*available to buy from our website*). Common damage can be caused by water pooling, garden/outdoor debris landing on it, sparks from nearby bonfires or firework displays landing on it.
- Keep animals/pets away from the trampoline, their claws can damage it.
- Protect from high winds. A trampoline can act like a sail in strong winds. It can be blown over which can cause damage to the frame and surrounding areas. We recommend that it is moved to a sheltered location and secured to the ground (*tie-down kit available from our website*), or dismantled and stored away.
- Dismantle and store away in a dry place if not being used for long periods. Follow assembly instructions in reverse order making sure the springs are removed before dismantling frame.
- Take care when moving trampoline. To be lifted by 2 people. Lift slightly off the ground, keeping the frame horizontal. Never drag to move it as this can displace parts. Always check that parts are positioned correctly after moving.

BUILDING YOUR TRAMPOLINE

1. This is a 2 person build.
2. Time for build is approximately 2 hours.
3. Choose a good location:
 - On a level surface that is soft(*wood chippings, sand or grass*).
 - Ensure adequate overhead clearance. A minimum of 24ft(7.3m) from ground level, away from wires, trees and other possible hazards.
 - Ensure a clear space of 8.2ft(2.5m) around sides, away from walls, fences, structures, tarmac and other hard surfaces and play areas.

WHAT YOU WILL NEED

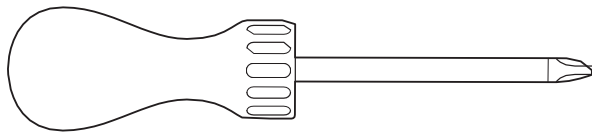

Description:
Cross-head screwdriver

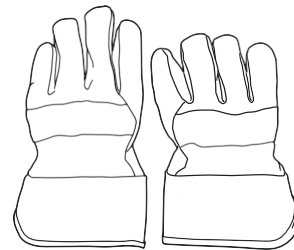

Description:
Gloves

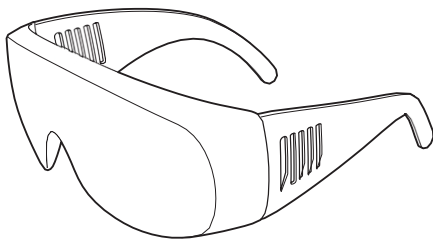



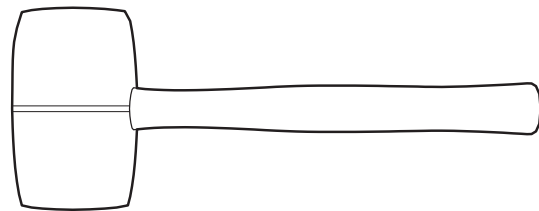









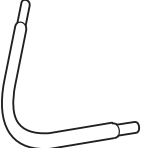

Description:
Safety glasses

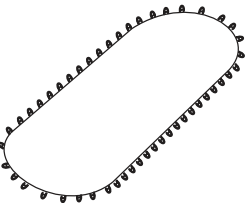
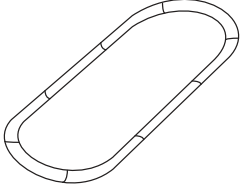
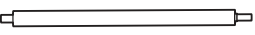

Description:
Mallet

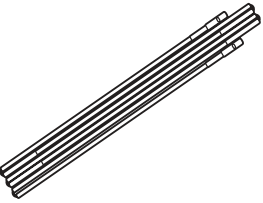
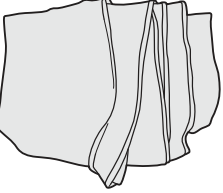
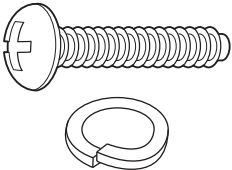
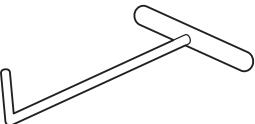
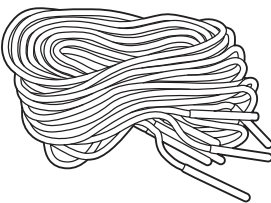
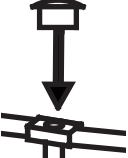
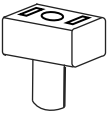
PARTS LIST

<p>Part A</p>  <p>Description: Top tube with A marking</p> <p>Quantity: 2</p>	<p>Part B</p>  <p>Description: Top tube with B marking</p> <p>Quantity: 2</p>	<p>Part C</p>  <p>Description: Top tube with C marking</p> <p>Quantity: 2</p>	<p>Part D</p>  <p>Description: Top tube with D marking</p> <p>Quantity: 2</p>	<p>Part E</p>  <p>Description: Top tube with E marking</p> <p>Quantity: 2</p>
<p>Part F</p>  <p>Top tube with F marking</p> <p>Quantity: 2</p>	<p>Part G</p>  <p>Description: L legs</p> <p>Quantity: 8</p>	<p>Part H</p>  <p>Description: V legs</p> <p>Quantity: 4</p>	<p>Part I</p>  <p>Description: 7inch Springs</p> <p>Quantity: 82</p>	<p>Part J</p>  <p>Description: 7inch Springs</p> <p>Quantity: 16</p>
<p>Part K</p>  <p>Description: Stitched bed</p> <p>Quantity: 1</p>	<p>Part L</p>  <p>Description: Frame pad</p> <p>Quantity: 1</p>	<p>Part M</p>  <p>Description: Bottom enclosure poles</p> <p>Quantity: 8</p>	<p>Part N</p>  <p>Description: Top enclosure poles</p> <p>Quantity: 8</p>	<p>Part O</p>  <p>Description: Black G4 poles</p> <p>Quantity: 2 Sections</p>
<p>Part P</p>  <p>Description: Enclosure netting</p> <p>Quantity: 1</p>	<p>Part Q</p>  <p>Description: Self tapping screws and spring washers</p> <p>Quantity: 24</p>	<p>Part R</p>  <p>Description: Spring tool</p> <p>Quantity: 1</p>	<p>Part S</p>  <p>Description: Cords</p> <p>Quantity: 8</p>	<p>Part T</p>  <p>Description: Cap connector</p> <p>Quantity: 8</p>
<p>Part U</p>  <p>Description: POD-connector</p> <p>Quantity: 8</p>	<p>Part V</p>  <p>Description: G3 Steel Connector (Have been attached to the G3 poles Part O)</p> <p>Quantity: 2</p>			

STEP 1 : ASSEMBLING THE FRAME

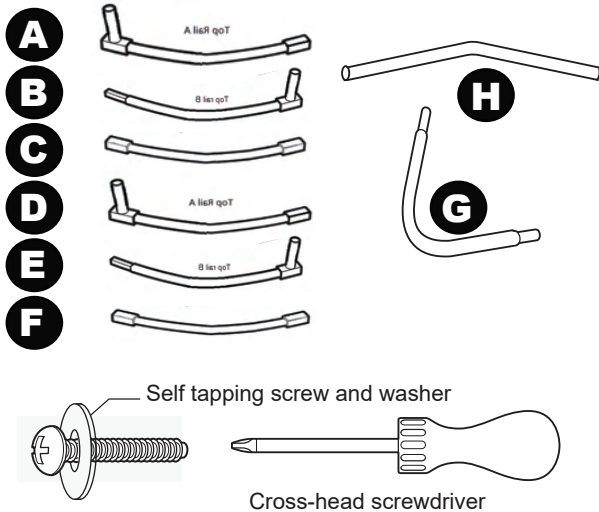

You will need the following parts to complete section 1:

- 2 x Top tube with A marking - **Part A and U**
- 2 x Top tube with B marking - **Part B and U**
- 2 x Top tube with C marking - **Part C**
- 2 x Top tube with D marking - **Part D and U**
- 2 x Top tube with E marking - **Part E and U**
- 2 x Top tube with F marking - **Part F**
- 8 x L legs - **Part G**
- 4 x V legs - **Part H**

16 x Self tapping screws and washers - **Part Q**
 You will also need a cross-head screwdriver (*not supplied*).

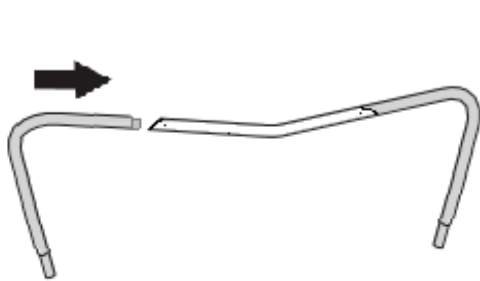

First you will need to assemble the leg bases of your OvalPOD. This will require 2 x L-legs and 1 x V Leg.

Note: Do not screw the sections together yet.

Lay out the 2 x L-legs and 1 x Centre Leg so that it makes a 'W' shape. Join the three pieces so the screw holes line up with the larger screw hole on the leg extension joining to the W-leg.

Repeat this step with the remaining pieces to make 4 x 'W Legs'. Leave to one side when finished.

Assemble 1 (A, B, C)

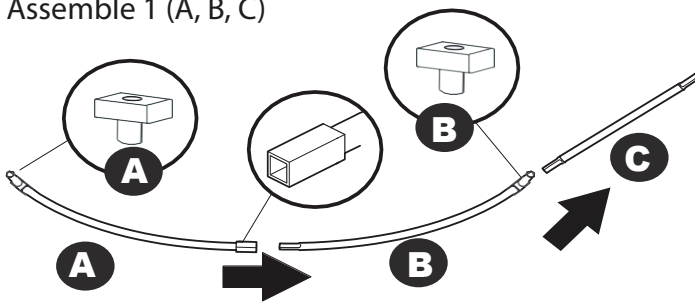

Layout Top Rail B, Top Rail A and Top Rail C curving away from you as if you are making the trampoline upside down and attach.

With the lettered stickers on the POD-connectors facing outwards and when you turn over the top rails you will be able to see a spring hole through in the gap of the POD-connector.

Assemble 1 (D, E, F)

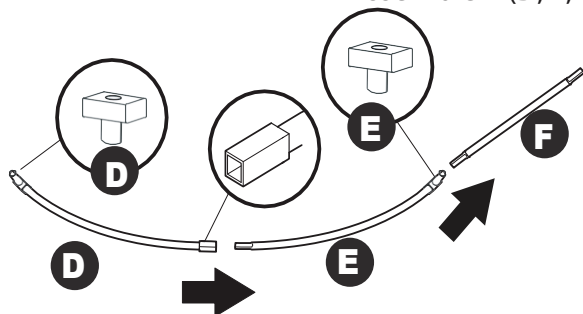

Layout Toprail D, E, and F curving away from you. Connect Top rail D first ensuring the reinforcement sleeve is on the left side and the lettered stickers on POD-connectors are facing outwards. Attach this to the other top rails.

STEP 2 : ASSEMBLING THE FRAME



Insert 1 end of W-leg partially into Connector A.

Next place feet either side of POD-Connector B.

Then pull other end of W-leg into POD-Connector B. (You will need to use force for this step)

Now push down on W-leg so inserted fully in each POD-connector now you can screw the legs together.

Repeat with other W-Legs

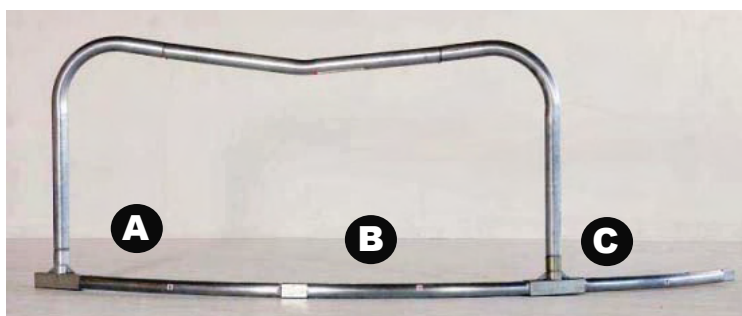

Now you have 4 completed segments

2 x Assembly 1 (ABC)

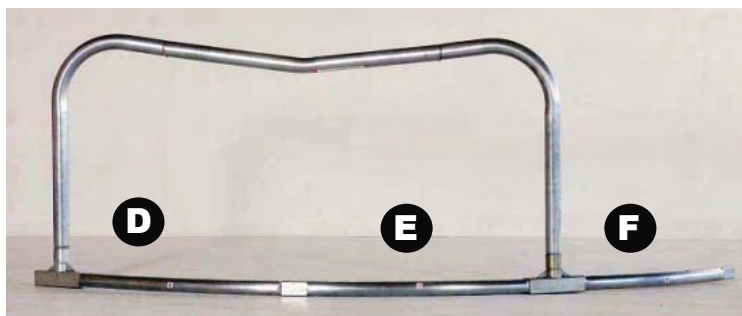

2 x Assembly 2 (DEF)

You will need two people for this next step.

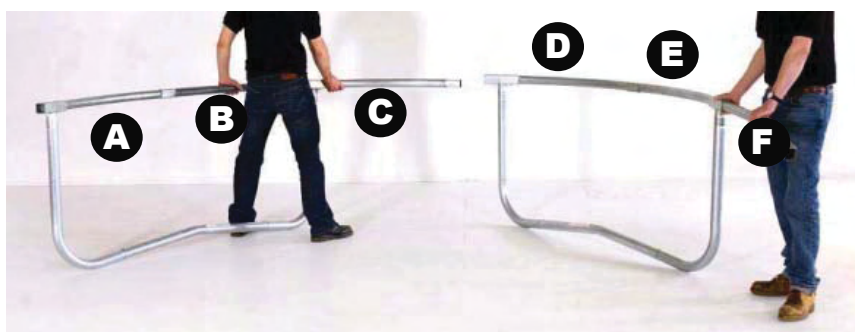

Turn over 1 x Assembly 1 (ABC) and 1 x Assembly 1 (DEF)

Join by inserting C into POD-connector D. (Make sure spring hole lines up with gap in connector)

Repeat this step so you are left with 2 halves of Trampoline



Carefully join the 2 halves together.

For the last section, you will need someone to stand on the opposite side of the frame and push towards you whilst you insert Top-rail into POD-Connector.

STEP 3 : FITTING THE STITCHED BED

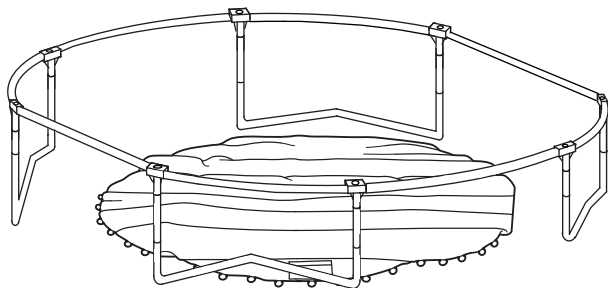

This step will require 2 people who must be wearing gloves and protective eye wear.

Lay the stitched bed (*with the V-Rings*) **part K** out inside the frame of the trampoline with the warning labels facing upwards.

Colored webbing

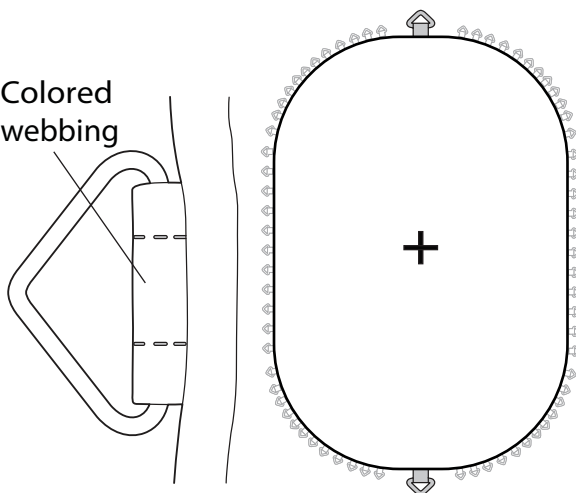

Locate the V-rings with coloured webbing. These will be at 180° to each other.

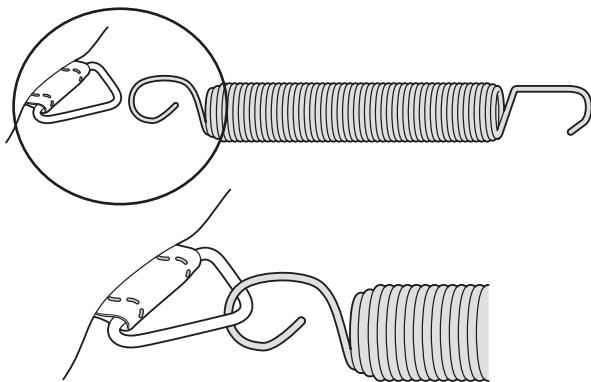

Slot one of the silver springs onto one of the coloured webbing V-rings as shown.

Important: springs must be slotted on the right way around.

See page 10 for spring diagram.

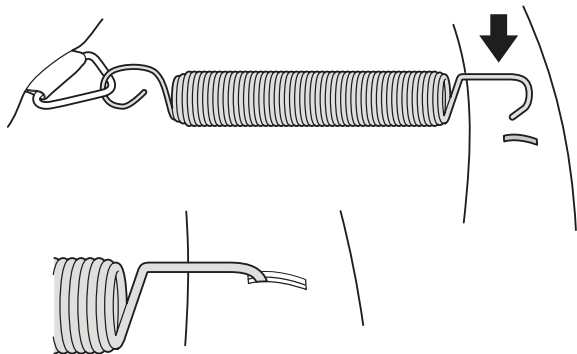

Slot the other end of the spring into one of the spring slots in the top of the frame.

IMPORTANT: Ensure the spring is fully inserted into the slot on the top of the frame.

This diagram shows the initial order of spring attachment.

○ = Bottom spring hole ● = Top spring hole

Important: Attach the springs in the order shown in the diagram. This will help to distribute the tension, making assembly easier.

Firstly, locate the 2 colored V-rings. These V-rings are to be attached at points 1 and 2 using a silver spring.

Then attach gold springs 3 to 20 in the order shown in the diagram. These are all gold top springs that attach to the POD-connector, as shown below:

Important: Remember to include the 'under spring' holes when counting the V-rings on the frame and bed.

Once all of the springs shown in the diagram have been fitted, the remaining springs can be attached.

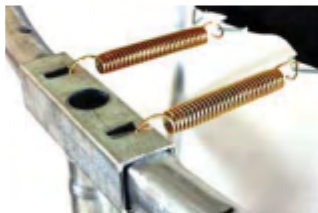
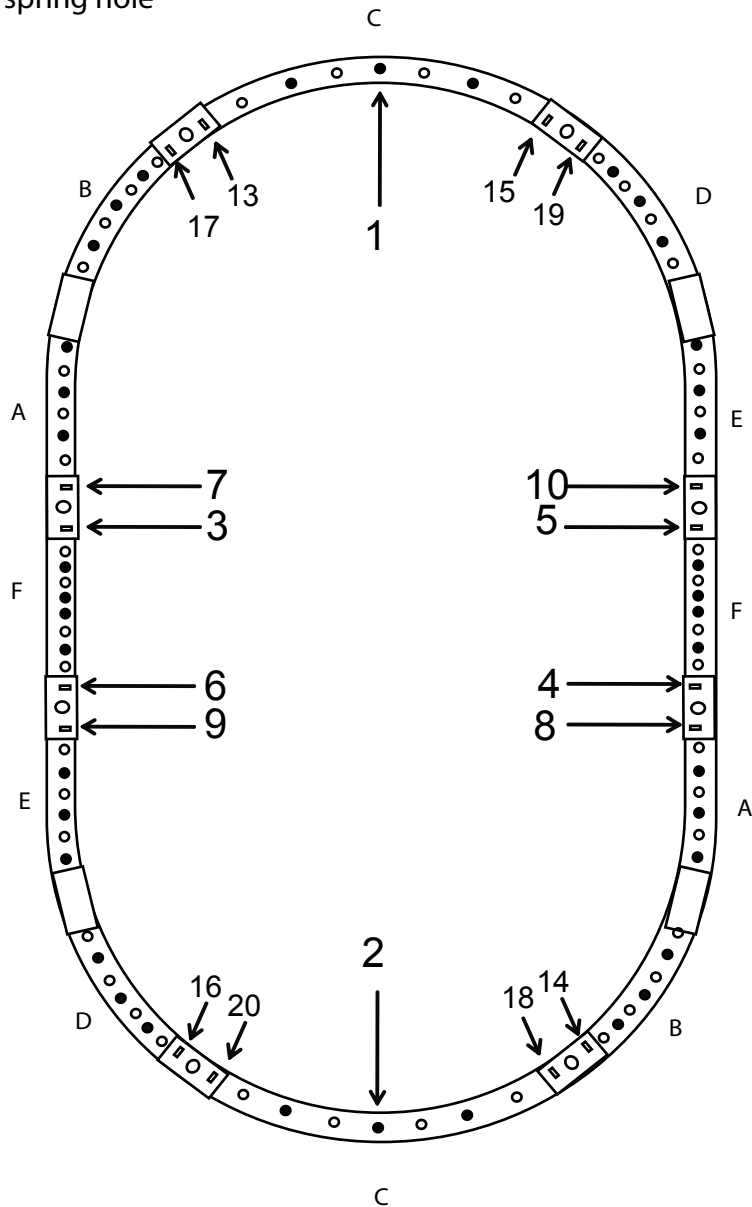

Then please attached the 'under springs' (10) to the underside of the top rail.



Continue to attach springs in the same sequence as above: in the middle of of each section, making sure the next spring is attached on the opposite side to even out the tension.

Important: The stitched bed is designed like elastic to be bouncy, which means that during construction it may look like it won't fit. Please note that it will stretch to the correct size when attaching the springs, this may take some force.

The stitched bed is now filled and you have completed step 3.

STEP 4 : FITTING THE FRAME PAD

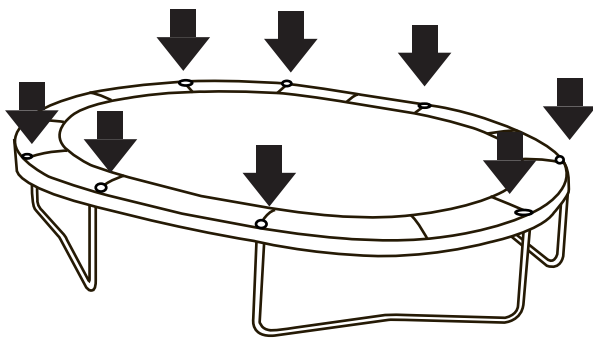

This step will require 2 people.

Lay the frame pad - **Part L** out over the edge of the frame with the ties facing downwards.

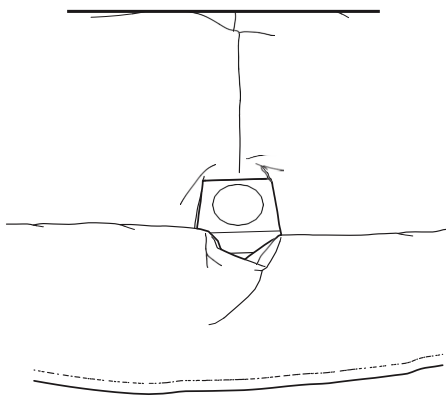

Align the openings in the frame pad with the POD-connector's on the frame.

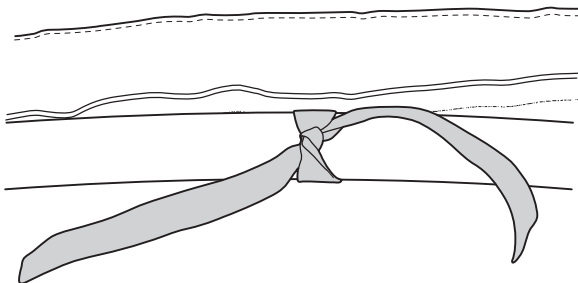

Tie the outer elastic straps on the underside of the frame pad around the top tubes of the frame.

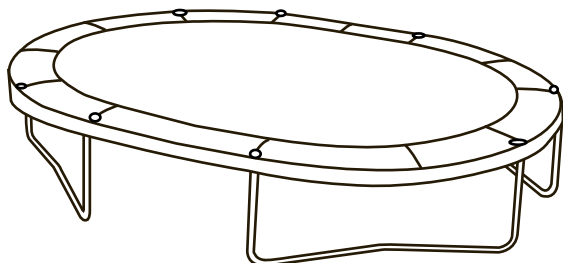

The frame pad is now fitted and you have completed step 4.

WARNING: The trampoline **MUST NOT** be used during construction.

STEP 5 : FITTING THE ENCLOSURE TUBES

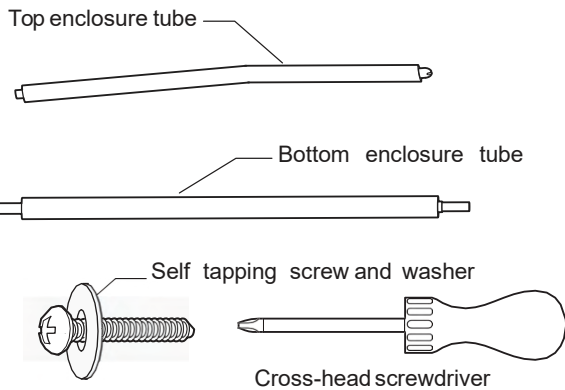

You will need the following parts to complete step 5:

8 x Top enclosure tubes - **Part M**

8 x Bottom enclosure tubes - **Part N**

8 x Self tapping screws and washers - **Part Q**

You will also need a cross-head screwdriver (*not supplied*).

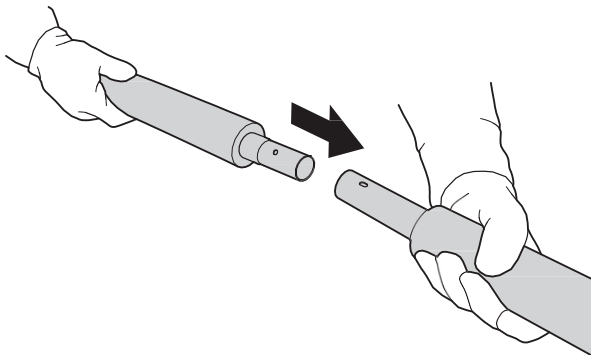

Slot the thin end of one of the bottom enclosure tubes into the open end of one of the top enclosure tubes.

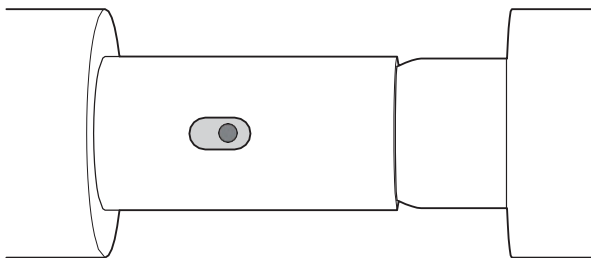

Align the hole in the bottom enclosure tube with the slot in the top enclosure tube.

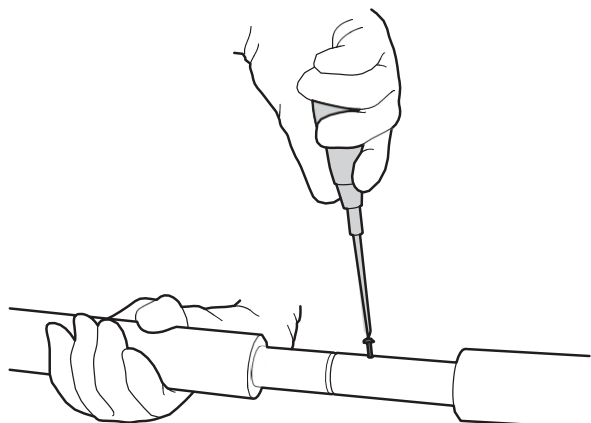

Screw one of the self tapping screws through the slot in the top enclosure tube and into the hole in the bottom enclosure tube using the cross-head screwdriver.

Please note the screw is larger than the hole. Some force will be needed to screw this in.

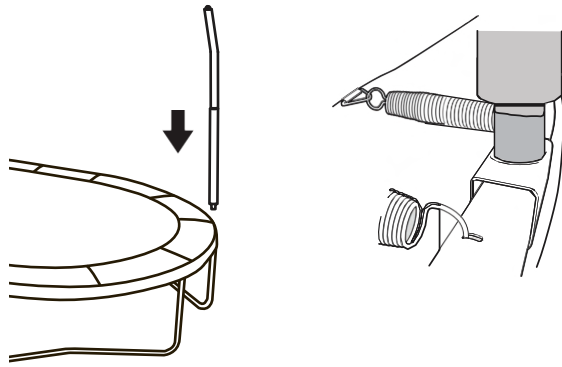

Slot the bottom enclosure tube into the tubes in the POD-connector tubes visible through the slots in the frame pad.

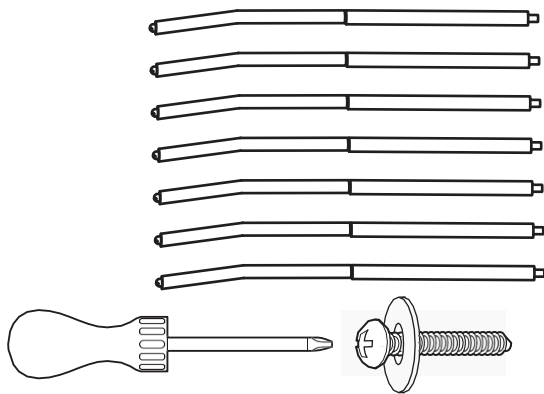

Assemble the remaining enclosure tubes using the self tapping screws and the cross-head screwdriver.

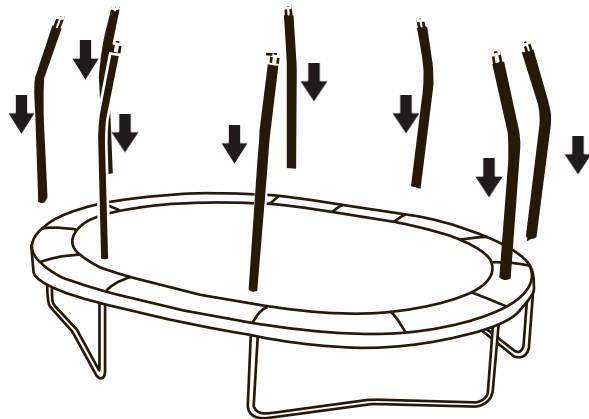

Slot the remaining enclosure tubes into the remaining POD-connectors on the frame.

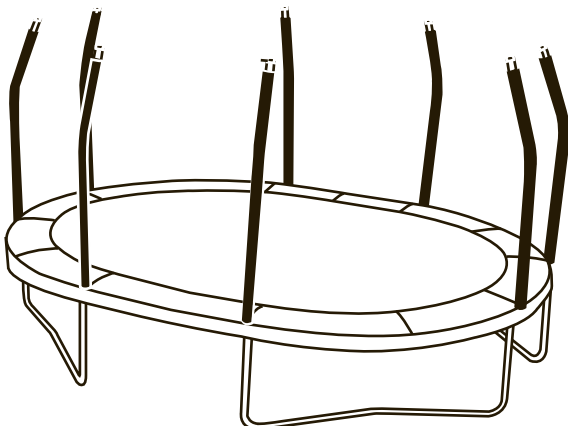

The enclosure tubes are now fitted and you have completed step 5.

STEP 6 : FITTING THE ENCLOSURE NETTING

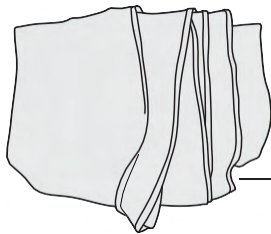
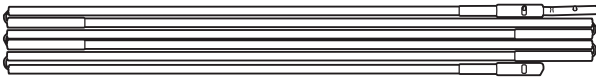

Black G4 poles

Enclosure netting

You will need the following parts to complete step 6:

2 x Black G4 poles - **Part O**

1 x Enclosure netting - **Part P**

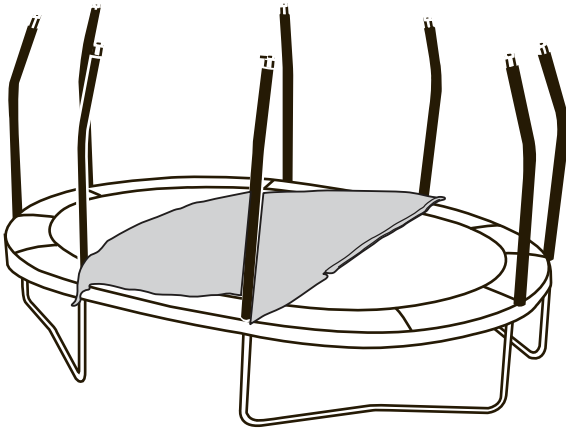

Lay the enclosure netting out on the trampoline.

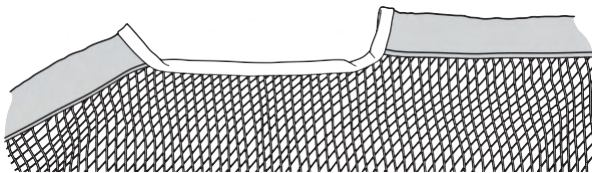

Find the sleeves that run along the top of the enclosure netting.



Slot the thin sections on the two black G4 poles into the metal ends so the poles become two long sections.

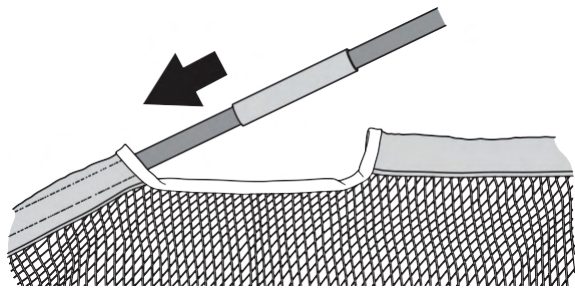

Slot one of the Black G4 poles through three of the sleeves on the top of the enclosure netting.

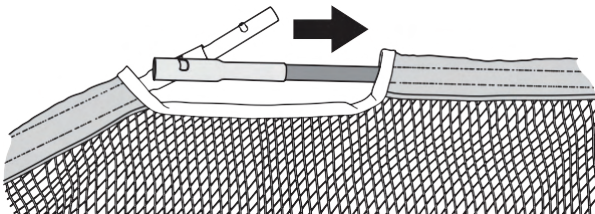

Slot the remaining Black G4 poles through the three other sleeves on the top of the enclosure netting.

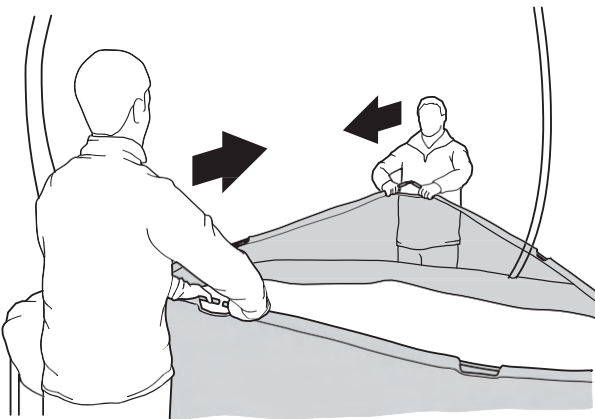

You will now join the two ends of the Black G4 poles together with the fitted pole connectors, this will require two people.

Both people hold two of the poles end sections and walk towards each other to bend the poles into a circle.

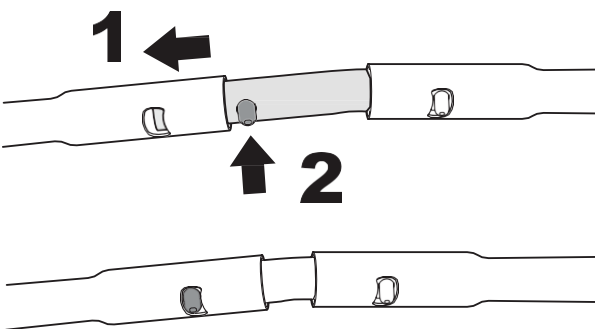

As soon as the poles are bent enough, insert the connectors into the socket on the other pole (1) Push the pin inwards (2) and fully insert the connector.

Ensure the pin is protruding through the slot in the socket.

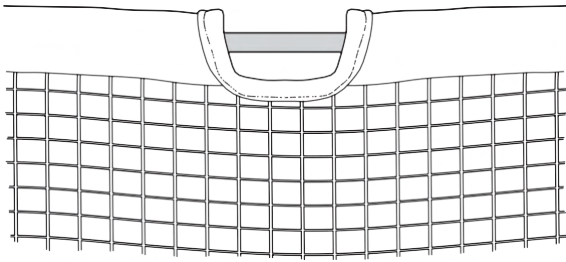

You may need to slide the connected poles around in the nettings sleeves until the thin black sections are aligned with the gaps between sleeves.

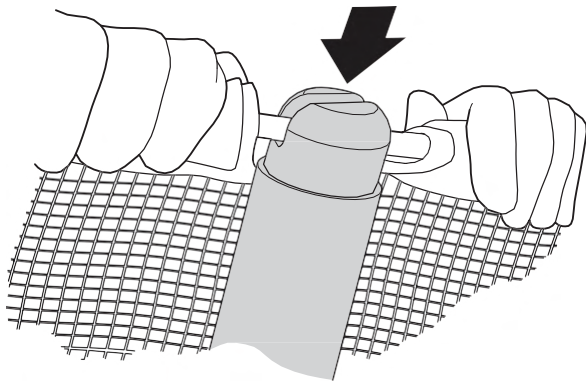

With the netting hanging on the inside of the enclosure poles, stand on the trampoline and insert one of the exposed sections of the Black G3 pole into a plastic grip on top of one of the enclosure tubes.

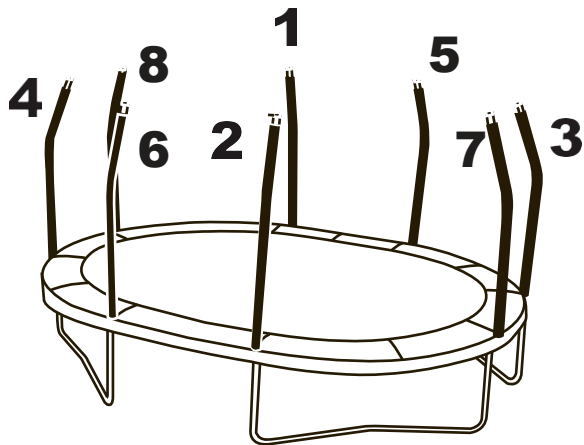

Attach the other exposed sections of the Black G4 pole to the other enclosure tubes in the order shown in the diagram.

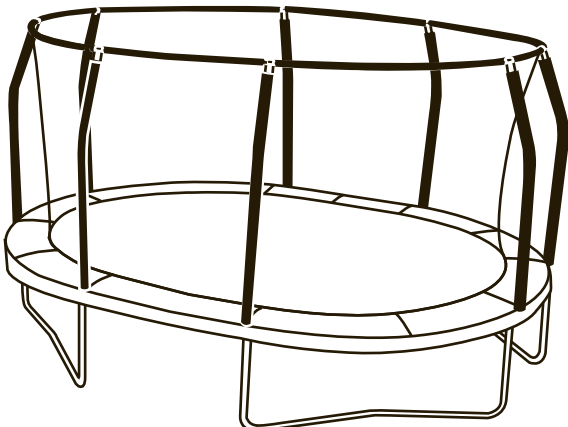

The enclosure net is now fitted and you have completed step 6.

STEP 7 : ATTACHING THE BOTTOM OF THE NET

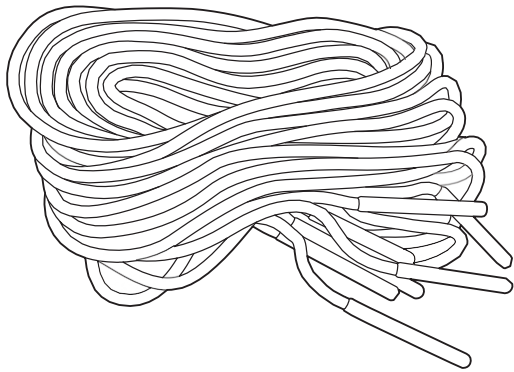

You will need the following parts to complete step 7:
8 x Cords - **Part S**.

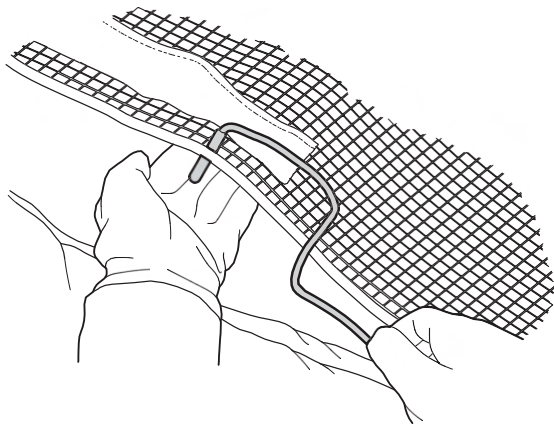

Push 1 end of a cord through a hole in the bottom of the netting.

Then tie this end to a V-ring on the bed.

Important: Keep the cord tight at all times.

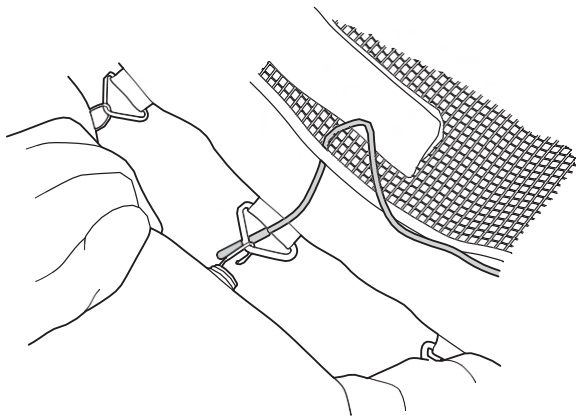

Slot the other end of the cord through the next V-ring.

Then slot back through the net and into the next V-ring. Continue to do this until you have used most of that cord and tie end to next V-ring.

Tie another cord to same V-ring and repeat until net is sewn in.

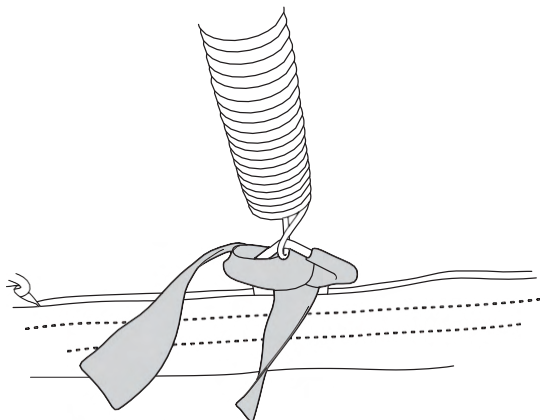

From the underside of the trampoline, tie the remaining elastic straps around the springs or through the V-Rings.

You have completed step 7 and the trampoline is fully assembled.

USING THE TRAMPOLINE

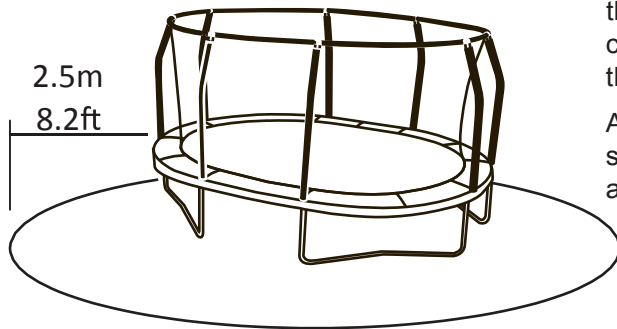

Before using your trampoline, check again that there is enough clearance around it. Maintain a clear space of 2.5 metres (8.2 feet) on all sides of the trampoline.

Also check that the area is free from walls, structures, fences, tarmac and other hard surfaces and other play areas.

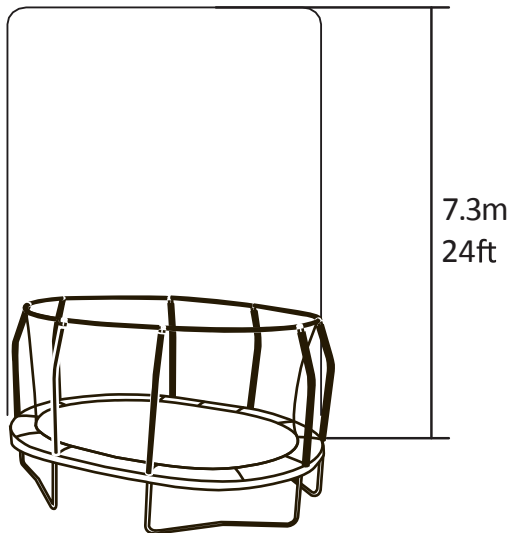

Ensure that there is 7.3 metres (24 feet) clearance above the trampoline.

Also check that there are no overhanging objects in the area above the trampoline.

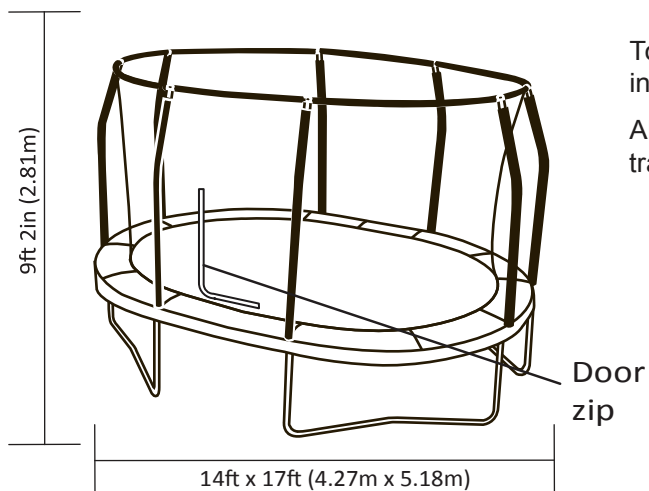

To enter the trampoline, unzip the door and climb in.

Always close the doorway before using the trampoline.

SPARE PARTS

To order replacement parts, you can email us on: customerservice@yjeurope.co.uk, or call our Customer Helpline on: 0344 800 4060.

To help us assist you, please provide the following information when calling:

- The PRODUCT DESCRIPTION: **14 FT x 17 FT JUMPPOD OVAL TRAMPOLINE**
- The KEY No. and DESCRIPTION of the part (see *parts list below*).
- The quantity needed.
- The desired method of shipping.

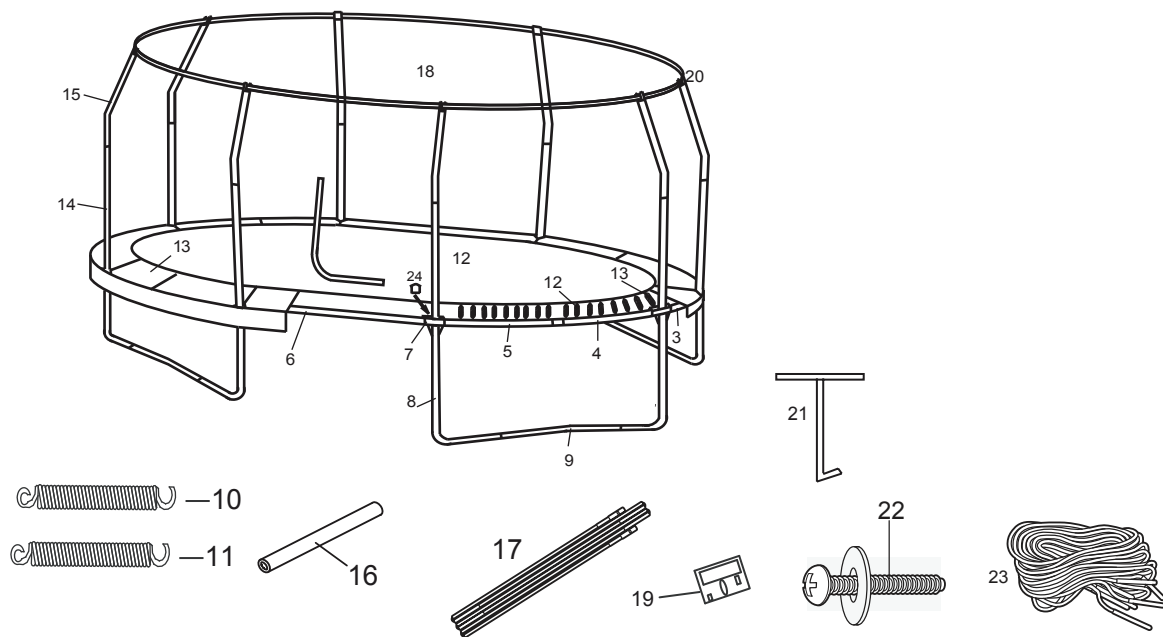

Key No.	Qty.	Description	Key No.	Qty.	Description
1	2	Top rail (4 top / 3 bottom, A marking)	12	1	Jumping mat
2	2	Toprail (4 top / 4 bottom, B marking)	13	1	Safety pad
3	2	Top rail (5 top / 4 bottom, C marking)	14	8	Enclosure bottom poles
4	2	Top rail (4 top / 4 bottom, D marking)	15	8	Enclosure top poles
5	2	Top rail (4 top / 3 bottom, E marking)	16	16	Foam sleeve
6	2	Top rail (6 top / 4 bottom, F marking)	17	2	G4 FRP
7	8	POD-connector (2 pcs A marking, 2 pcs B marking, 2 pcs D marking, 2 pcs E marking)	18	1	Enclosure mesh
8	8	L legs	19	1	User manual
9	4	V legs	20	8	Plastic caps
10	82	7" length springs	21	1	Spring tool
11	16	7" length gold springs	22	24	Screw + spring washer
			23	8	PP rope
			24	8	Plastic caps for connector

For a full range of accessories and replacement parts call 0344 800 4060 or visit our web site at: www.jumpking.eu

