

Monteringsanvisning

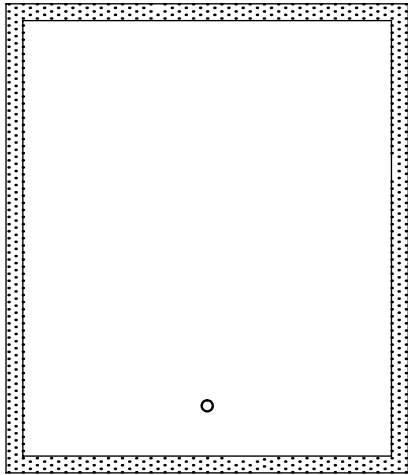

Spejlets forside

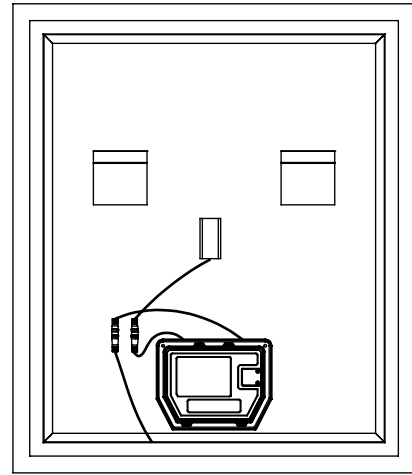

Spejlets bagside

Tip: Ujævnhederne på væggen bør ikke overstige 0,5 mm

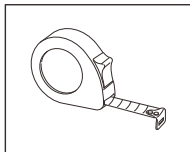
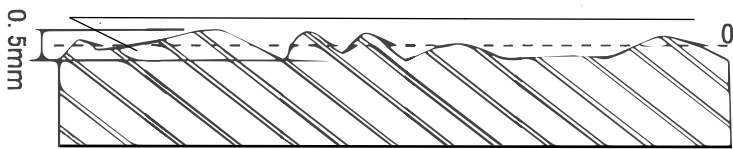

Målebånd

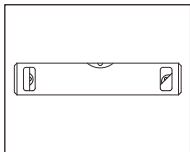

Vatterpas

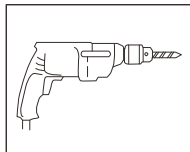

Boremaskine

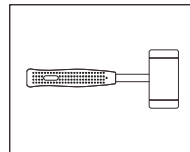

Hammer

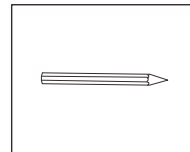

Blyant

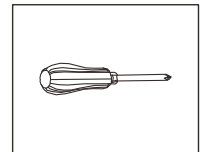

Skruetrækker

Spejl

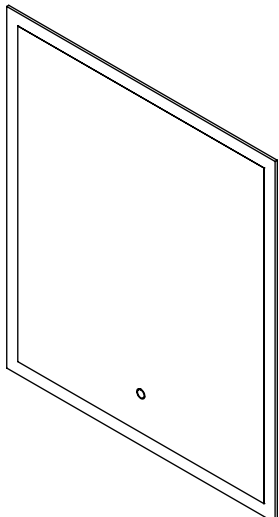

X1

Plugs

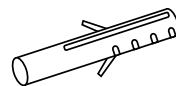

X4

Monteringsbeslag

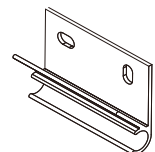

X2

Skrue

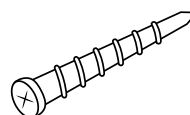

X4

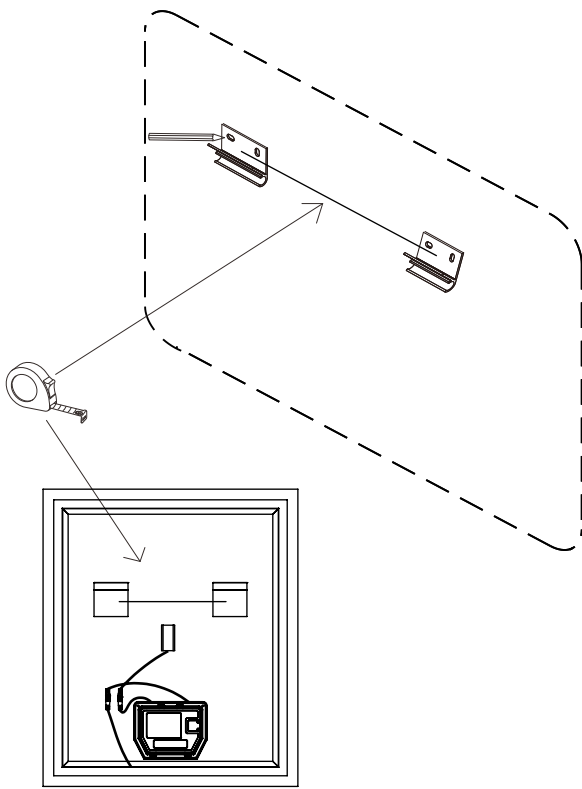

1. Mål afstanden mellem beslagene på spejlet, mærk så placeringen af hullerne på væggen.

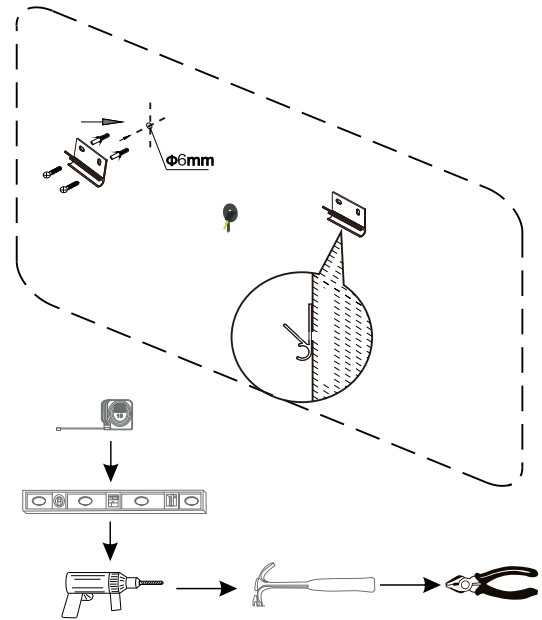

2. Bor et 6 mm hul i markeringerne og put pluggen i hullerne. Som vist på billedet, fastgør beslaget på væggen med skruberne.

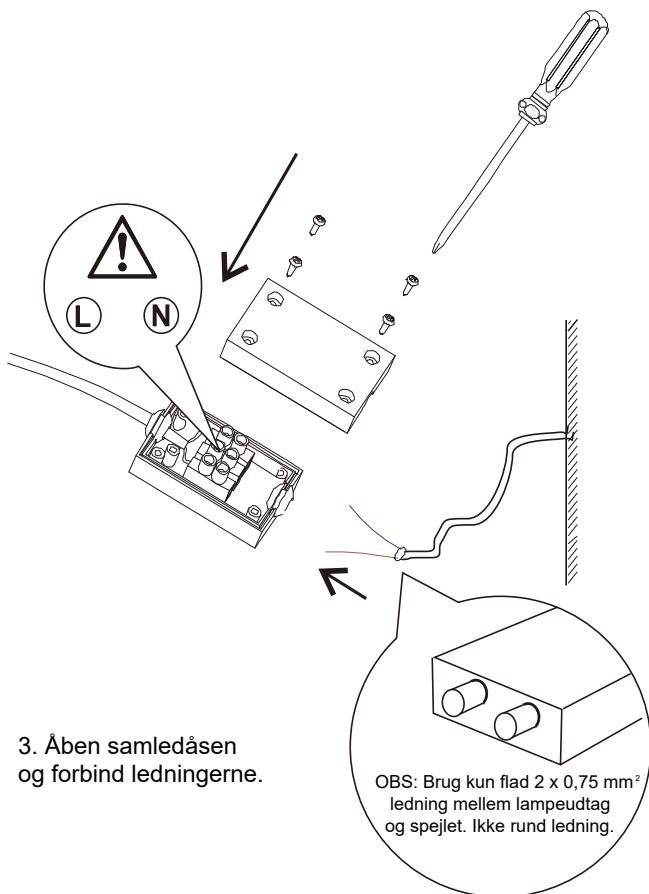

3. Åben samledåsen og forbind ledningerne.

OBS: Brug kun flad 2 x 0,75 mm² ledning mellem lampeudtag og spejlet. Ikke rund ledning.

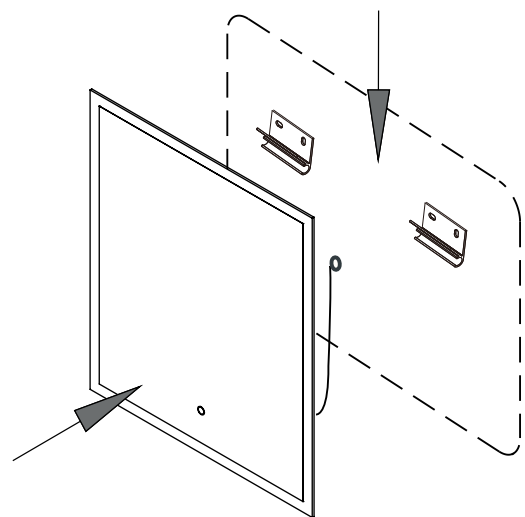

4. Hæng spejlet op på væggen som på billedet.