

546210-1 + 546211-1
 546220-1 + 546221-1
 546230-1 + 546231-1
 546240-1 + 546241-1
 546250-1 + 546251-1
 546260-1 + 546261-1

PLUS

PLUS A/S
 Ådalen 13B
 DK-6600 Vejen
 phone: +45 7996 3333
 web: www.plus.dk

(Vejl. varenr. 177055)

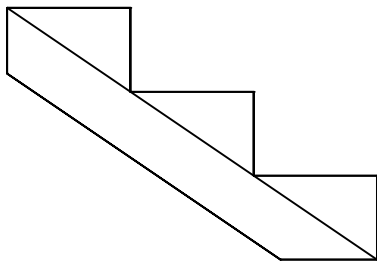

2 = 546219
 3 = 546226
 4 = 546233
 5 = 546240
 6 = 546264
 7 = 546254

Se side 2+3 for antal
 Siehe Seite 2+3 für Zahlen
 See page 2+3 for numbers
 Se sidorna 2+3 för nummer
 Voir page 2+3 pour les numéros

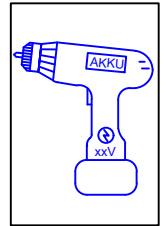

120 cm = 52848-1

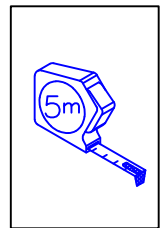

180 cm = 52853-1

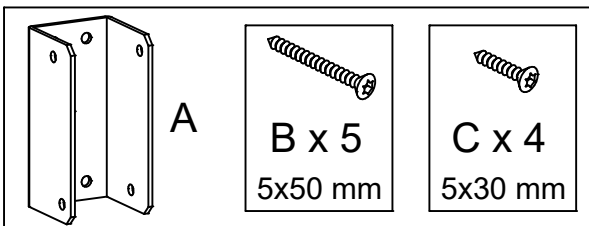

546296 = Beslagspose / Beschäge / Fittings
 Rördelar / Raccords.

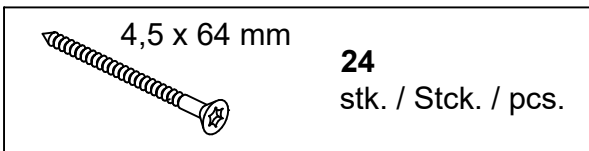

8517 = Skruemose / Schrauben / Screws /
 Skrupåse / Sac à vis.

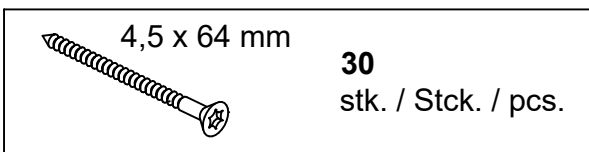

8518 = Skruemose / Schrauben / Screws /
 Skrupåse / Sac à vis.

Se www.plus.dk for yderligere information og vedligehold af materialer.
 Weitere Informationen und Pflegehinweise finden Sie unter www.plus.dk.
www.plus.dk for further information and maintenance of materials.
 Se www.plus.dk för ytterligare information och underhåll av material.
 Voir www.plus.dk pour plus d'informations et d'entretien de matériel.



Kun til privat brug.
 Nur für privaten Gebrauch.
 For private use only.
 Réservé à un usage privé.

Revideret januar 2024

546210-1

2 - Trin/Stufen/Step/Steg/E'tapes

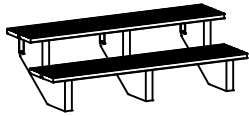

3 x 546219
3 x 546296
4 x 52848-1
1 x 8517 (24)

546211-1

2 - Trin/Stufen/Step/Steg/E'tapes

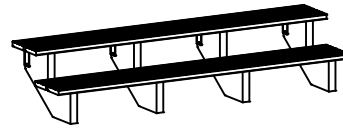

4 x 546219
4 x 546296
4 x 52853-1
2 x 8517 (24)

546220-1

3 - Trin/Stufen/Step/Steg/E'tapes

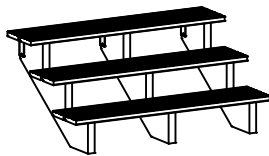

3 x 546226
3 x 546296
6 x 52848-1
2 x 8517 (24)

546221-1

3 - Trin/Stufen/Step/Steg/E'tapes

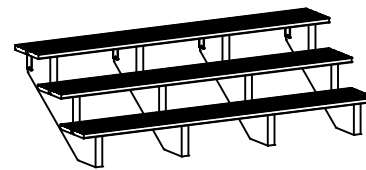

4 x 546226
4 x 546296
6 x 52853-1
2 x 8517 (24)

546230-1

4 - Trin/Stufen/Step/Steg/E'tapes

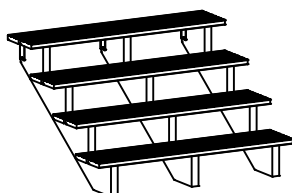

3 x 546233
3 x 546296
8 x 52848-1
2 x 8517 (24)

546231-1

4 - Trin/Stufen/Step/Steg/E'tapes

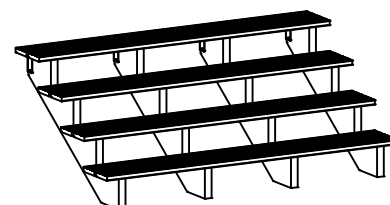

4 x 546233
4 x 546296
8 x 52853-1
3 x 8517 (24)

546240-1

5 - Trin/Stufen/Step/Steg/E´tapes

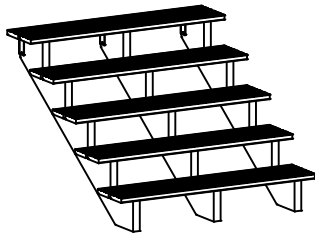

3 x 546240
3 x 546296
10 x 52848-1
2 x 8518 (30)

546241-1

5 - Trin/Stufen/Step/Steg/E´tapes

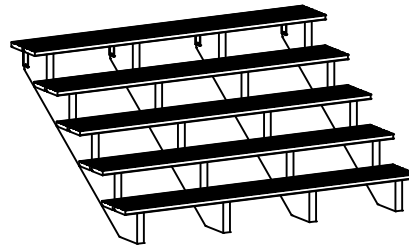

4 x 546240
4 x 546296
10 x 52853-1
3 x 8518 (30)

546250-1

6 - Trin/Stufen/Step/Steg/E´tapes

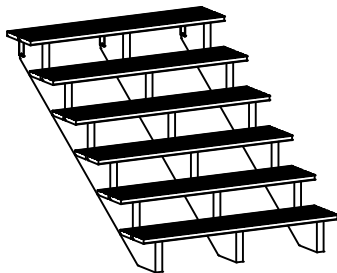

3 x 546264
3 x 546296
12 x 52848-1
3 x 8517 (24)

546251-1

6 - Trin/Stufen/Step/Steg/E´tapes

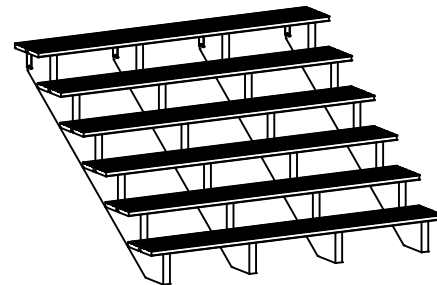

4 x 546264
4 x 546296
12 x 52853-1
4 x 8517 (24)

546260-1

7 - Trin/Stufen/Step/Steg/E´tapes

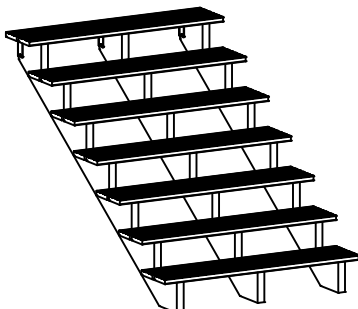

3 x 546254
3 x 546296
14 x 52848-1
3 x 8518 (30)

546261-1

7 - Trin/Stufen/Step/Steg/E´tapes

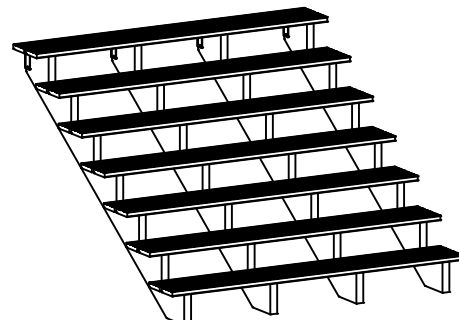

4 x 546254
4 x 546296
14 x 52853-1
4 x 8518 (30)

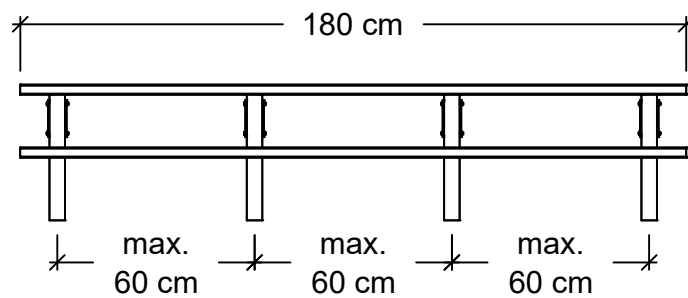
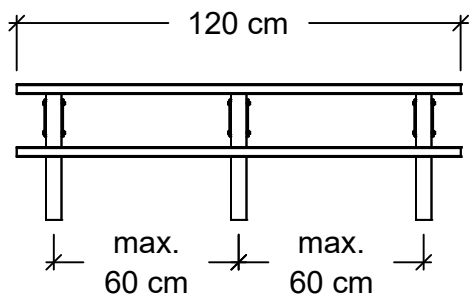

Placering af trappevanger:

Afstanden mellem vangerne må maksimalt være 60 cm.

For at overholde bæreevnen.

Punktlast = 200 kg.

Fladelast = 150 kg./m²

Platzierung der Treppenwangen:

Der Abstand zwischen den Wangen darf maximal 60 cm betragen.

Zur Einhaltung der Tragfähigkeit.

Punktlast = 200 kg.

Flächenlast = 150 kg./m²

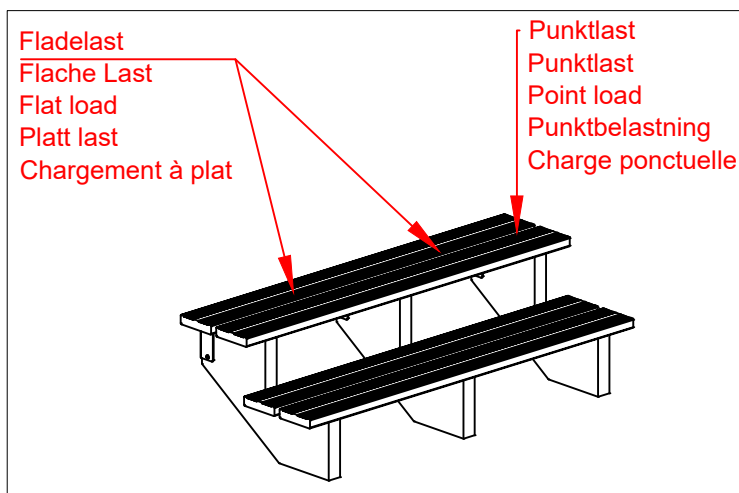

Placement of stair stringers:

The distance between the stringers must be a maximum of 60 cm.

To comply with the load-bearing capacity.

Point load = 200 kg.

Flat load = 150 kg./m²

Placering av trappsteg:

Avståndet mellan vangstyckena får vara högst 60 cm.

För att uppfylla bärförmågan.

Punktlast = 200 kg.

Platt belastning = 150 kg./m²

Placement des limons de l'escalier :

La distance entre les limons doit être de 60 cm au maximum.

Pour respecter la capacité de charge.

Charge ponctuelle = 200 kg.

Charge plane = 150 kg./m²

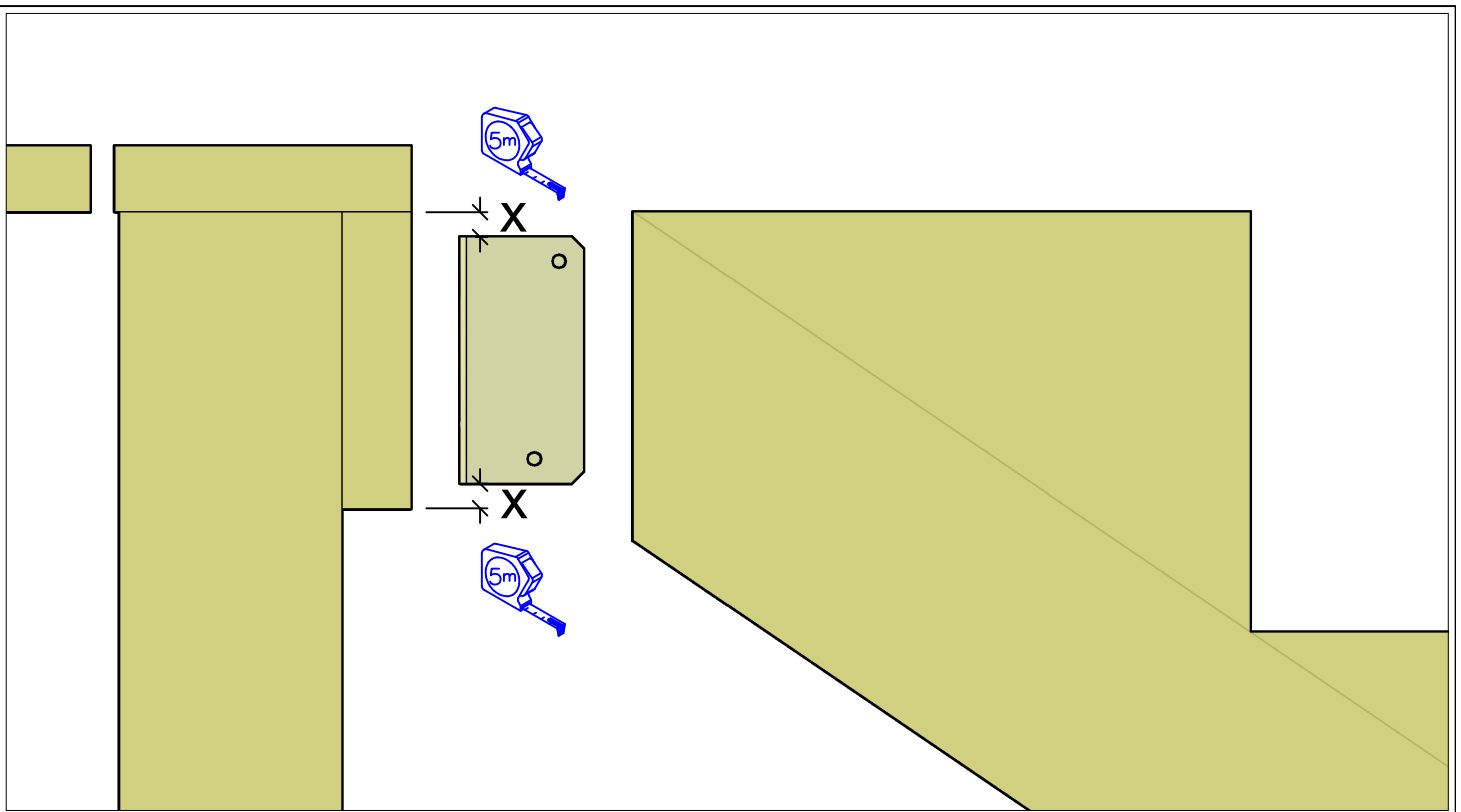

DK: Afmærk hvor beslaget skal placeres.

DE: Markieren Sie die Stelle, an der die Halterung angebracht werden soll.

UK: Mark where the bracket should be placed.

S: Markera var konsolen skall placeras.

F: Marquez l'endroit où le support doit être placé.

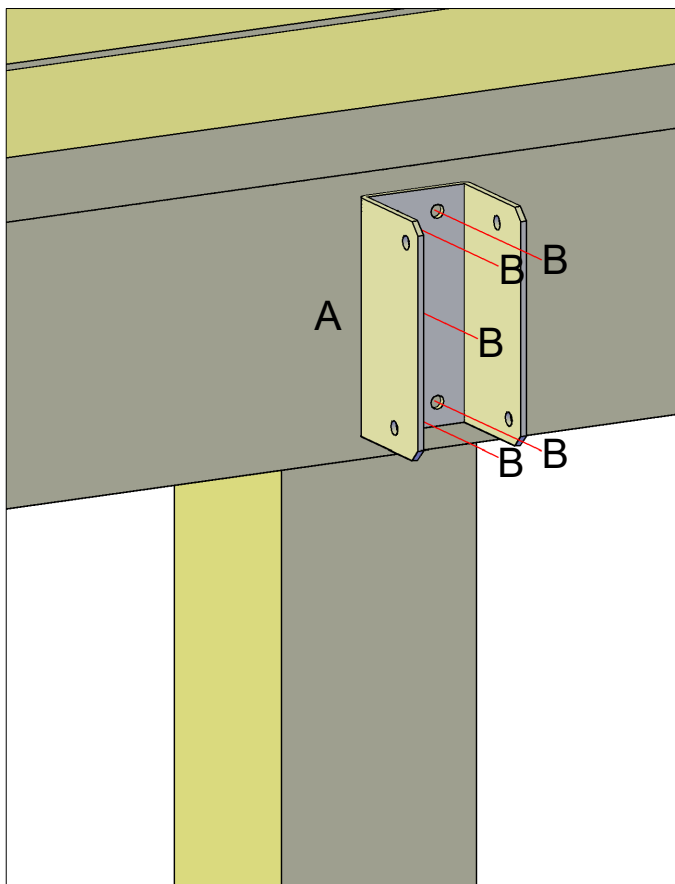

DK: Medfølgende skruer er kun til brug i trækonstruktion.

DE: Die mitgelieferten Schrauben sind nur für den Einsatz in Holzkonstruktionen geeignet.

UK: Supplied screws are for use in wooden construction only.

S: Medföljande skruvar är endast avsedda för användning i träkonstruktioner.

F: Les vis fournies sont destinées à être utilisées dans les constructions en bois uniquement.

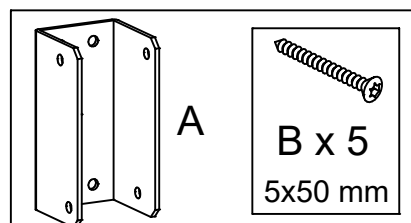

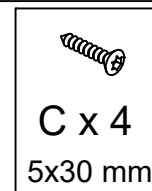
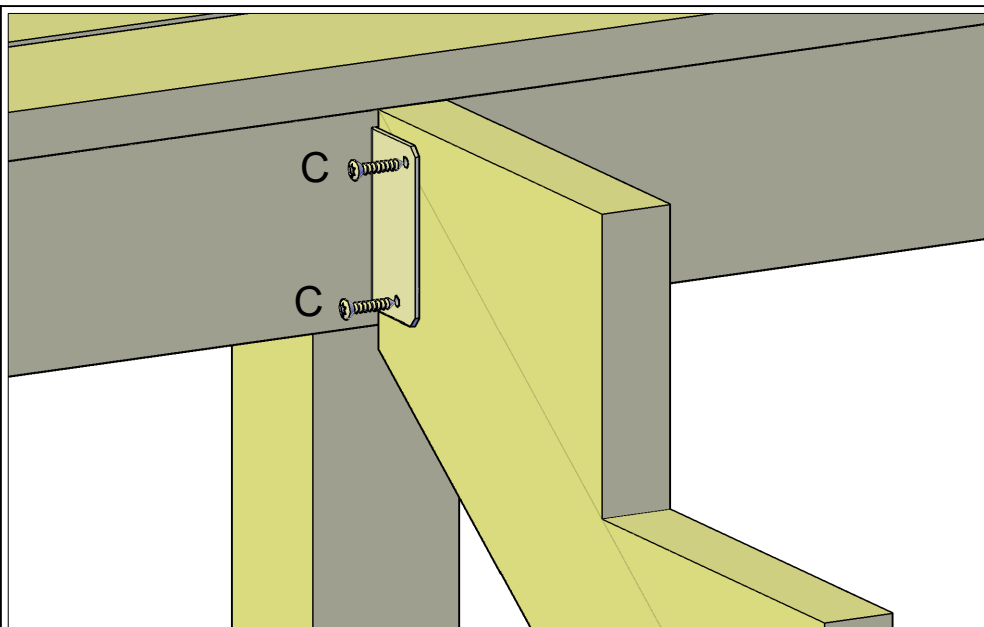

DK: Vi anbefaler fliser eller tilsvarende som underlag.
Samt en *fugtspærre (f.eks. murpap) mellem trappevange og underlag.
Dette medfølger ikke fra PLUS.

DE: Wir empfehlen Fliesen oder ähnliches als Untergrund.
Und eine *Dampfsperre (z. B. eine Mauerkarton) zwischen der
Treppenwangen und dem Untergrund.
Diese ist nicht im Lieferumfang von PLUS enthalten.

UK: We recommend tiles or similar as a base.
And a *vapour barrier (e.g. masonry cardboard) between the stairs and
the base.
This is not included from PLUS.

S: Vi rekommenderar kakel eller
liknande som underlag.
Och en *ångspärr (t.ex. kartong
för murverk) mellan trapp och
underlag.
Detta ingår inte från PLUS.

F: Nous recommandons l'utilisation
de carreaux ou d'un matériau
similaire comme base.
Et un *pare-vapeur (par exemple,
carton de maçonnerie) entre le
nez de marche et la base.
*Ceci n'est pas compris dans les
PLUS.*

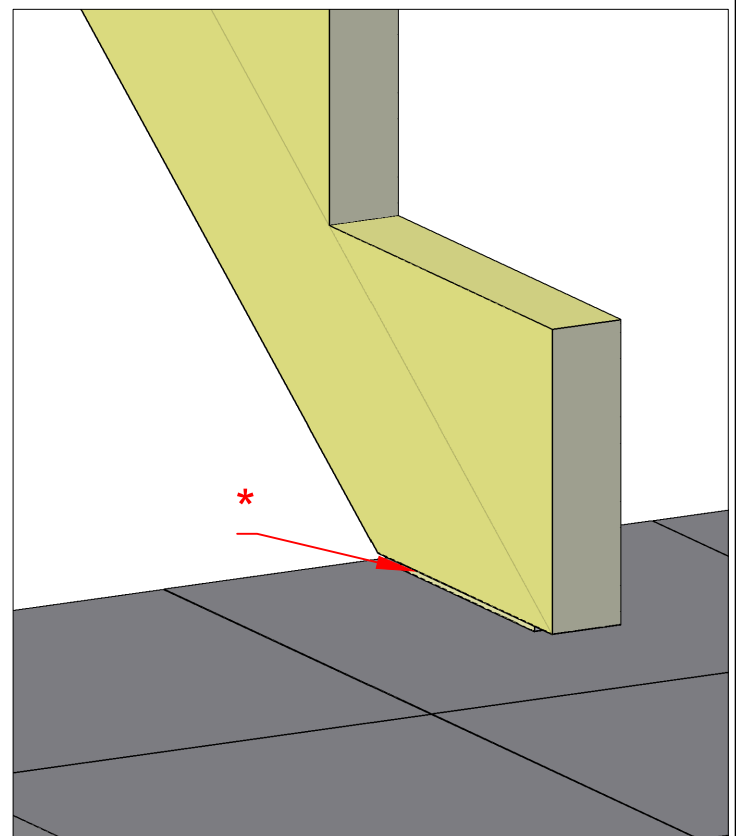

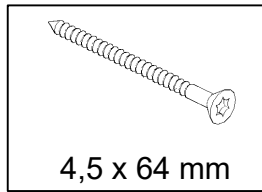
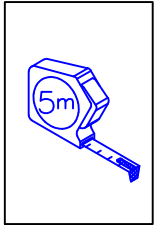

4,5 x 64 mm

