



DK

NO

SE

FI

GB

DE

PL

ET

ES

IT

NL

FR

# PROBUILDER

DESIGNED TO WORK

Brugsanvisning · Bruksanvisning · Bruksanvisning  
Käyttöohje · Instruction manual · Gebrauchsanweisung  
Podręcznik użytkownika · Kasutusjuhend  
Manual de instrucciones · Manuale di istruzioni  
Gebruiksaanwijzing · Manuel d'instructions

# Opbevaringsløsning til garagen

## INTRODUKTION

For at du kan få mest mulig glæde af dit nye produkt, beder vi dig gennemlæse denne brugsanvisning, før du tager produktet i brug. Vi anbefaler dig desuden at gemme brugsanvisningen, hvis du senere skulle få brug for at genopfriske din viden om produktets funktioner.

## TEKNISKE SPECIFIKATIONER

Skab med 2 døre og 3 hylder.  
66 x 45,7 x 198,1 cm. (BxDxH).

2 overskabe med 2 døre.  
66 x 30,5 x 40,6 cm. (BxDxH)

2 værktøjstavler med huller til kroge  
66 x 68,4 x 2 cm. (BxDxH).

Bordplade af massivt træ  
132 x 45,7 x 2,5 cm. (BxDxH).

Modul med 4 skuffer  
66 x 45,7 x 86,4 cm. (BxDxH).

Skab med 2 døre og hylde.  
66 x 45,7 x 86,4 cm. (BxDxH).

## SÆRLIGE SIKKERHEDSVEJLEDNINGER

Opbevaringsløsningen til garagen skal stå oprejst og være fastgjort til en bagvæg. Den må ikke stå frit!

Det anbefales at være 2 personer til at flytte, samle og montere skabsinventaret. I modsat fald kan det medføre rygskada eller andre personskader.

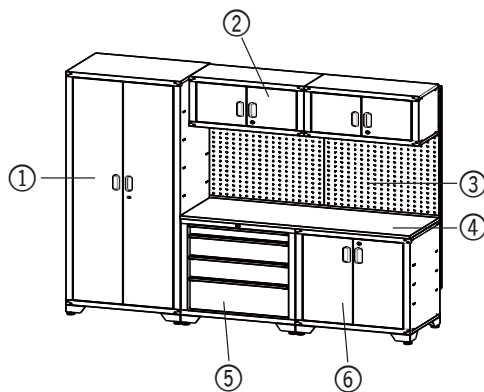

## DELE AF OPBEVARINGSLØSNING TIL GARAGEN

1. Skab med 2 døre og 3 hylder
2. 2 overskabe
3. 2 værktøjstavler
4. Bordplade
5. Modul med 4 skuffer
6. Skab med 2 døre og hylde

# Dele

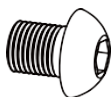

Skrue M8\*10

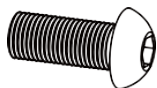

Skrue M8\*18



Flangemøtrik M8



Skrue M5\*10

Møtrik  
M5

Træskruer M6\*60

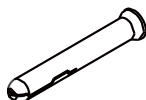

Rawplug

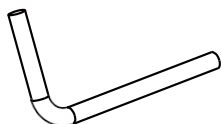
Metalspændeskive  
Ø22,8Selvskærende skrue  
M5\*15

Dørhængsel

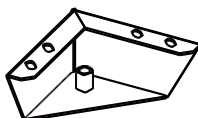

Stålnivelleringsben

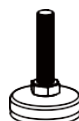
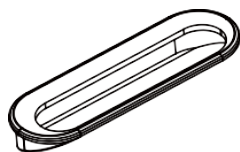
Justerbar  
nivellerings-  
anordning med  
gevindHånd-  
tag

Gummiring



Sekskantnøgle

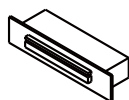

Skrue M6\*16

Metalspænde-  
skive Ø12,5Spænde-  
skive til  
dørhængsel

Dørstopper



Nøgle

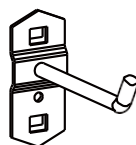

Krog

## Liste over dele

	Boks 1	Boks 2	Boks 3	Boks 4	Boks 5	Boks 6
Navn/antal						
Skrue M8*10	16	16	16	16	0	0
Skrue M8*18	0	4	4	4	4	0
Flangemøtrik M8	16	20	20	20	0	0
Skrue M5*10	18	6	6	9	0	0
Møtrik M5	6	2	2	9	0	0
Skrue M6*16	16	0	0	16	16	0
Metalspændeskive Ø12,5	16	0	0	16	16	0
Træskruer M6*60	0	4	4	0	8	0
Rawlplug	0	4	4	0	8	0
Metalspændeskive Ø22,8	0	4	4	0	8	0
Selvskærende skruer M5*15	0	0	0	4	4	0
Dørhængsel	4	4	4	4	0	0
Spændeskive til dørhængsel	4	4	4	4	0	0
Stålnivellerings- ben	4	0	0	4	4	0
Justerbar nivelle- ringsanordning med gevind	4	0	0	4	4	0
Håndtag	2	2	2	2	0	0
Dørstopper	4	4	4	4	0	0
Gummiring	1	0	0	0	0	0
Sekskantnøgle	0	0	0	0	1	0
Nøgle	2	2	2	2	2	0
Krog	0	0	0	0	10	0

# Samling

## Højt opbevaringsskab BOKS 1

DK

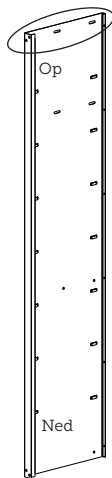

Venstre sidepanel 1 stk.



Bagpanel 2 stk.

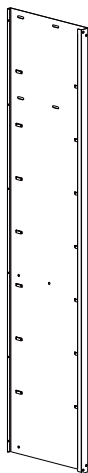

Højre sidepanel 1 stk.

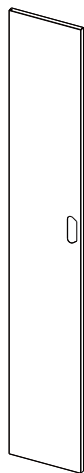

Venstre dør 1 stk.

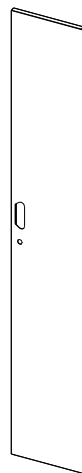

Højre dør 1 stk.

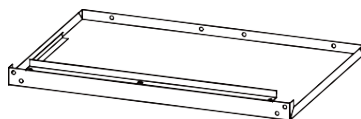

Toppanel 1 stk.

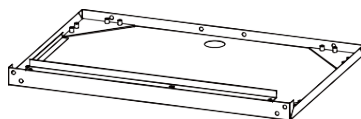

Bundpanel 1 stk.

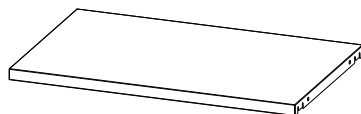

Hylde 3 stk.

### TRIN 1

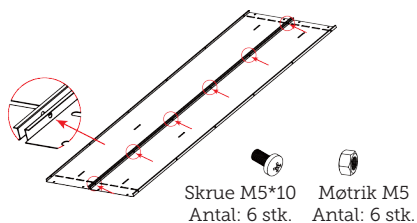

Læg de to bagpaneler fladt ned, og forbind dem med M5\*10-skruer og møtrikker. Kontroller, at det øverste og nederste endehul er i samme position.

### TRIN 2

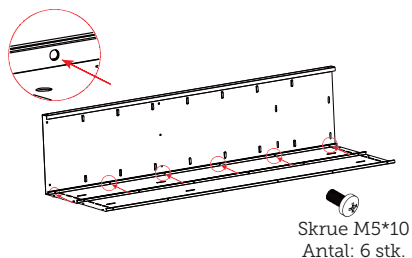

Placer det venstre panel som vist, og forbind det med bagpanelet med M5\*10-skruer. Vær opmærksom på placeringen af de øvre og nedre endehuller.

### TRIN 3

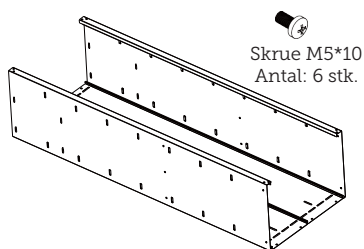

Monter det højre sidepanel i henhold til det andet trin. Vær opmærksom på placeringen af de øvre og nedre endehuller. De to sideplader er symmetriske.

### TRIN 4

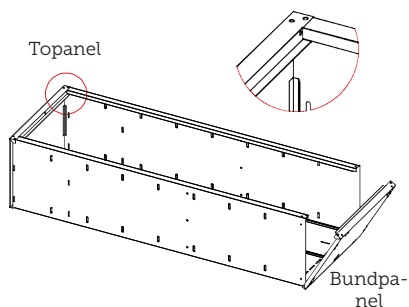

For at montere top- og bundpanelerne skal sidepanelerne sættes ind mellem de trekantede linjer på indersiden af top- og bundpanelerne og siderne. Den ene ende af de fire runde huller i sidepladen er den øverste ende.

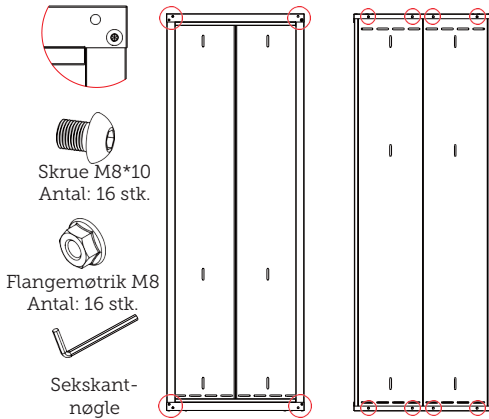
**TRIN 5**

Skru top- og bundpanelerne fast til sidebaggpanelerne.

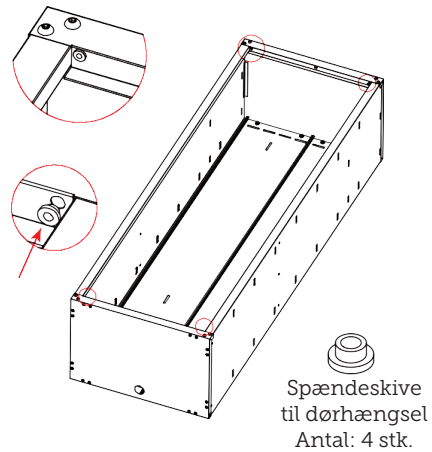
**TRIN 6**

Monter spændeskive til dørhængsel på de fire hjørner af top- og bundpladerne.

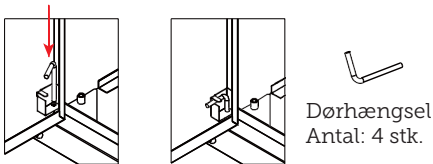
**TRIN 7**

For at montere venstre dør skal du justere dørhængselshullet i bunden af venstre dør ind efter midten af spændeskiverne til dørhængsel på venstre side af bundpladen, indsætte dørhængselet og derefter fastgøre dørhængselet til spændeskiverne til dørhængsel. Monter dørhængselet og den højre dør på samme måde.

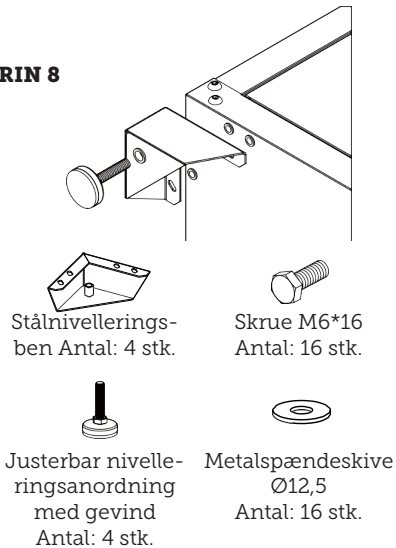
**TRIN 8**

Skru den justerbare nivelleringsanordning med gevind ind i bunden af stålnivelleringsbenet, og brug 4 M6\*16-skruer til at fastgøre stålbenet til bunden af bundpanelet, så ydersiden er på linje med bundpanelet. Monter de tre andre fødder på samme måde.

## TRIN 9

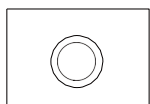
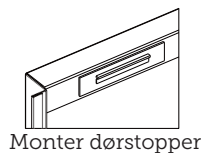

Gummiet er monteret bag på bundpanelet.



## TRIN 10

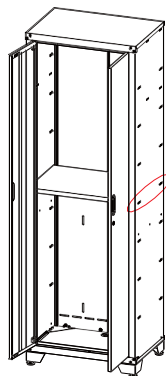

Stil skabet oprejst, monter en af hylderne i midten af skabet (til låsning af døren), og de to andre hylder skal monteres, hvor det er praktisk muligt.

## Over skabe BOKS 2 og 3

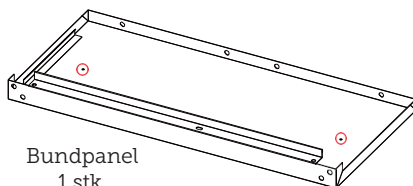
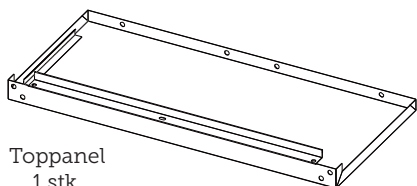
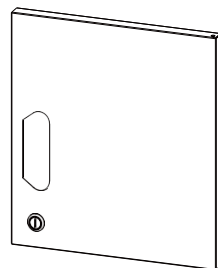
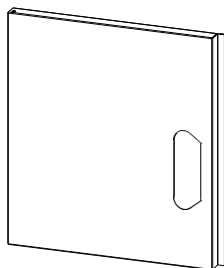
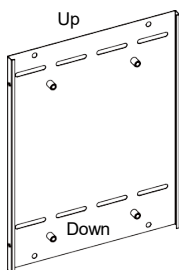
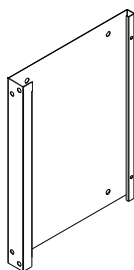

Monter overskabene ligesom det høje skab. Det øverste skab har ingen hylder eller gummiringe, så disse to ting skal du ignorere.



# Skab BOKS 4

DK

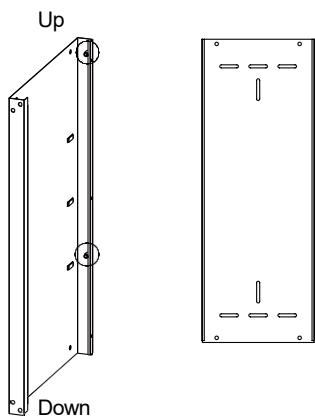

Venstre sidepanel 1 stk.

Bagpanel 2 stk.

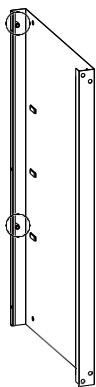

Højre sidepanel 1 stk.

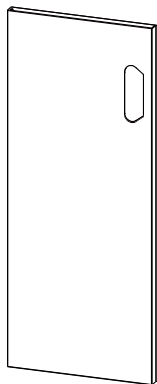

Venstre dør 1 stk.

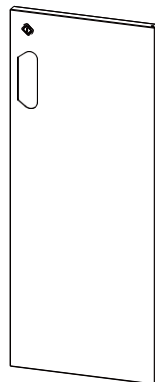

Højre dør 1 stk.

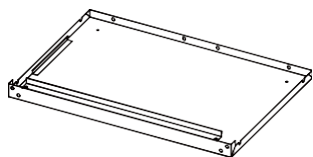

Toppanel 1 stk.



Monter underskabet i henhold til monteringsvejledningen til det høje skab.



I trin 2 og trin 3 forbindes sidepanelet og bagpanelet med bolte og møtrikker.

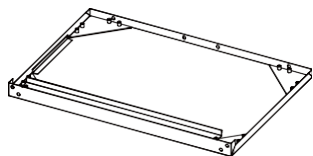

Bundpanel 1 stk.



Møtrik M5  
Antal: 9 stk.



Skrue M5\*10  
Antal: 9 stk.



Trin10 Hylde kan justeres efter ønske.

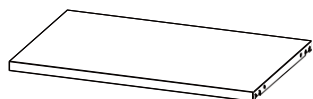

Hylde 1 stk.

# Tilslutningshuller

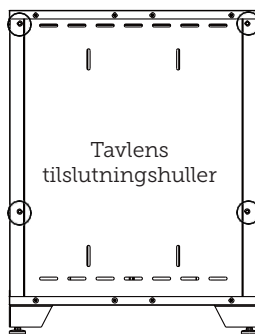
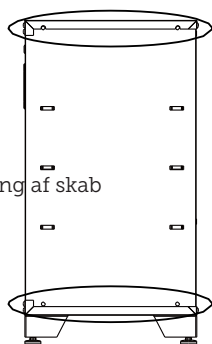
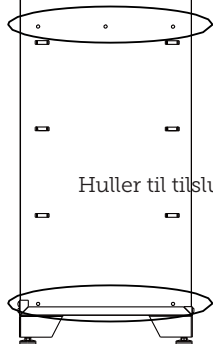
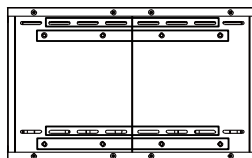
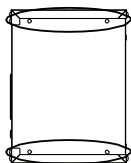

Høje skab set fra højre

Skab set fra siden

Skab set bagfra

Bordpladens tilslutningshuller

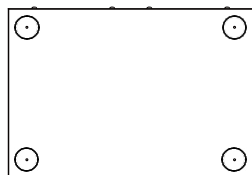

Skab set ovenfra

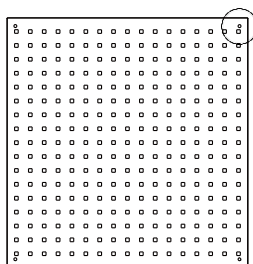

Værktøjstavle

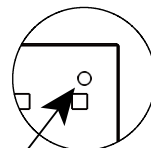

Vægskabets tilslutningshul

# Monteres på væggen

DK

## TRIN 1

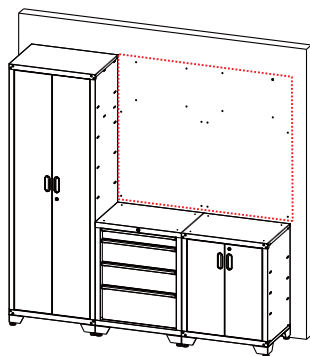

Rawplugg  
Antal: 16 stk.

Planlæg placeringen af værktøjsskabet, bestem placeringen af forbindelseshullet mellem værktøjstavlen og overskabet, og fastgør derefter rawpluggen. Fødderne på det høje skab og underskabet kan hæves, og rawpluggens placering kan være lidt højere.

## TRIN 2

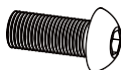

Skrue M8\*18  
Antal: 8 stk.



Flangemøtrik M8  
Antal: 4 stk.

Anbring det høje skab og overskabet på deres respektive positioner, juster dem og tilslut dem parvis. Der er monteret nittermøtrikker på sidepanelerne af skuffeskabet, så der er ikke behov for at bruge møtrikkerne ved sammenkobling med de andre skabe.

## TRIN 3

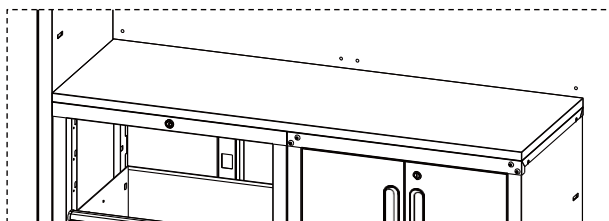

Selvskærende skrue  
M5\*15  
Antal: 8 stk.

Monter bordpladen. Skru de selvskærende skruer ind i bordpladen gennem monteringshullerne på toppen af skabet, og sørg for, at bordpladen er på linje med ydersiden af underskabet.

Fjern flere skuffer, hvis det er nødvendigt, og sæt skufferne på plads igen.

## TRIN 4

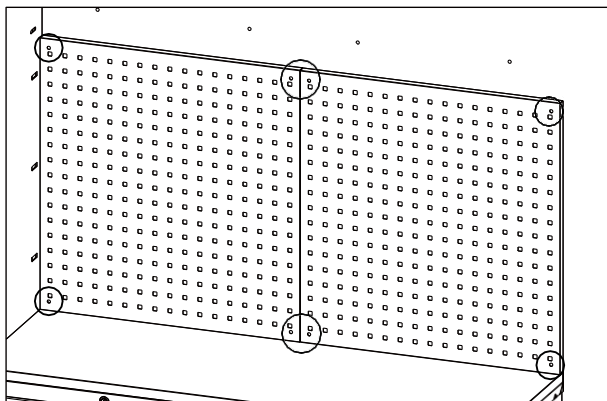

Træskrue M6\*60  
Antal: 8 stk.



Metalspændeskive Ø22,8  
Antal: 8 stk.

Monter værktøjstavlen. De store selvskærende skruer skal gå gennem de runde huller i de fire hjørner af værktøjstavlen og skrues ind i vægsticket på væggen for at fastgøre værktøjstavlen til væggen.

## TRIN 5

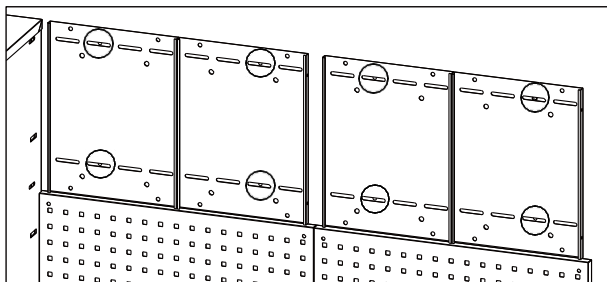

Træskrue M6\*60  
Antal: 8 stk.



Metalspændeskive Ø22,8  
Antal: 8 stk.

For at installere skabet skal du skrue den store selvskærende skrue gennem hullet på vægskabets bagpanel ind i vægsticket for at fastgøre skabet.

## TRIN 6

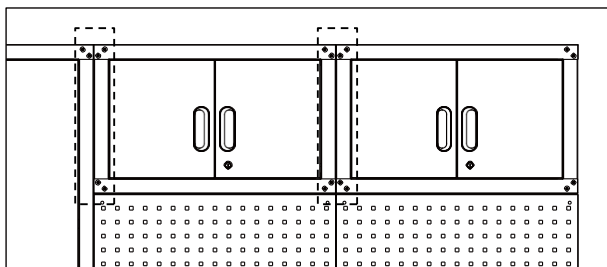

Skrue M8\*18  
Antal: 8 stk.



Flangemøtrik M8  
Antal: 8 stk.

Der anvendes bolte og møtrikker mellem overskabe og det høje skab.

---

**SERVICECENTER**

Bemærk: Hav altid produktets modelnummer klar, når du henvender dig.

Modelnummeret står på forsiden af denne vejledning samt på produktets dataplade.

*Til:*

- Klager
- Udskiftning af dele
- Returnering
- Henvendelser angående garanti
- [www.schou.com](http://www.schou.com)

---

Fremstillet i Kina

Fabrikant:

Schou Company A/S  
Nordager 31  
6000 Kolding  
Danmark

Alle rettigheder forbeholdes. Indholdet af denne vejledning må ikke gengives, hverken helt eller delvist, på elektronisk eller maskinel vis, f.eks. fotokopiering eller publicering, ej heller oversættes eller gemmes i et system til opbevaring og hentning af data uden skriftlig tilladelse fra Schou Company A/S.

---

# Garasjeoppbevaring

## INNLEDNING

For at du skal få mest mulig glede av det nye produktet ditt, ber vi deg lese gjennom denne bruksanvisningen før du tar produktet i bruk. Vi anbefaler dessuten at du tar vare på bruksanvisningen i tilfelle du senere skulle trenge å lese informasjonen om produktets funksjoner på nytt.

## TEKNISKE DATA

Skap med 2 dører og 3 hyller.  
66 x 45,7 x 198,1 cm. (BxDxH)

2 overskap med 2 dører hver.  
66 x 30,5 x 40,6 cm. (BxDxH)

2 verktøyplater med hull for kroker  
66 x 68,4 x 2 cm. (BxDxH)

Benkeplate laget av massivt tre  
132 x 45,7 x 2,5 cm. (BxDxH)

Modul med 4 skuffer  
66 x 45,7 x 86,4 cm. (BxDxH)

Skap med 2 dører og hylle.  
66 x 45,7 x 86,4 cm. (BxDxH)

## SPESIELLE SIKKERHETSINSTRUKSJONER

Garasjeoppbevaringen må stå oppreist og festes til en bakvegg. Det må ikke stå fritt!

Det anbefales at det er to personer som flytter, setter sammen og monterer kabinettene. Unnlattelse av å gjøre dette kan føre til ryggskade eller lignende.

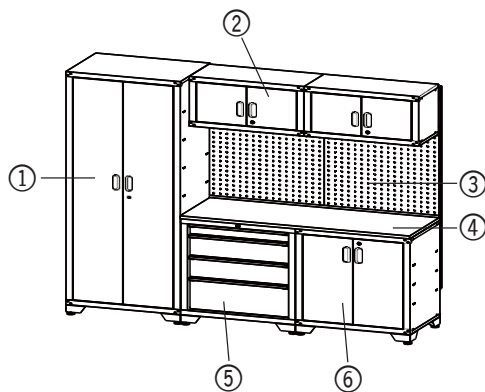

## DELER AV GARASJEOPPBEVARINGEN

1. Skap med 2 dører og 3 hyller
2. 2 overskap
3. 2 verktøyplater
4. Benkeplate
5. Modul med 4 skuffer
6. Skap med 2 dører og hylle

# Deler

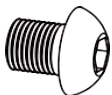

Skrue M8\*10

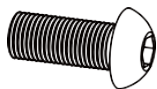

Skrue M8\*18



Flensmutter  
M8



Skrue M5\*10

NO



Mutter  
M5



Treskrue M6\*60

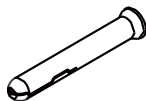

Veggplugg



Metallskive Ø22,8



Selvgjengende skrue  
M5\*15

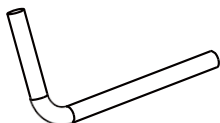

Dørhengsel

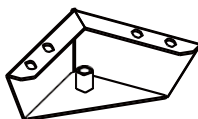

Stålfeste for justerbare bein

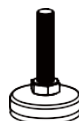

Justerbare bein

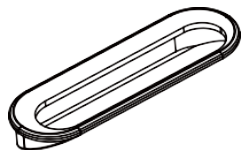

Håndtak



Gummiring



Unbra-  
konøkkel

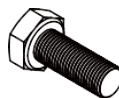

Skrue M6\*16



Metallskive  
Ø12,5



Skive for  
dørhengsel

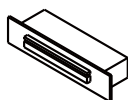

Dørstopper



Nøkkel

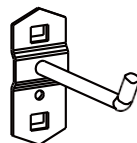

Krok

## Liste over deler

	Box1	Box2	Box3	Box4	Box5	Box6
Navn/antall						
Skrue M8*10	16	16	16	16	0	0
Skrue M8*18	0	4	4	4	4	0
Flensmutter M8	16	20	20	20	0	0
Skrue M5*10	18	6	6	9	0	0
Mutter M5	6	2	2	9	0	0
Skrue M6*16	16	0	0	16	16	0
Metallskive Ø12,5	16	0	0	16	16	0
Treskrue M6*60	0	4	4	0	8	0
Veggplugg	0	4	4	0	8	0
Metallskive Ø22,8	0	4	4	0	8	0
Selvgjengende skrue M5*15	0	0	0	4	4	0
Dørhengsel	4	4	4	4	0	0
Skive for dørhengsel	4	4	4	4	0	0
Stålfeste for justerbare bein	4	0	0	4	4	0
Justerbare bein	4	0	0	4	4	0
Håndtak	2	2	2	2	0	0
Dørstopper	4	4	4	4	0	0
Gummiring	1	0	0	0	0	0
Unbrakonøkkel	0	0	0	0	1	0
Nøkkel	2	2	2	2	2	0
Krok	0	0	0	0	10	0



# Montering

## Høyt oppbevaringsskap, BOX1

NO

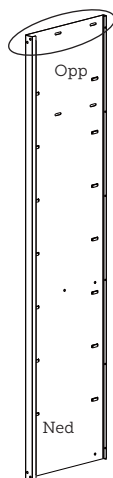

Venstre sidepanel, 1 stk.



Bakplater, 2 stk.

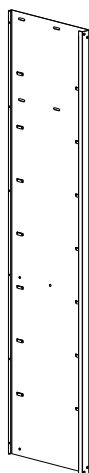

Høyre sidepanel, 1 stk.

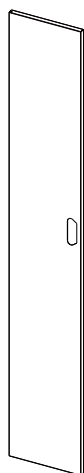

Venstre dør, 1 stk.

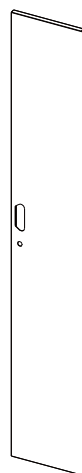

Høyre dør, 1 stk.

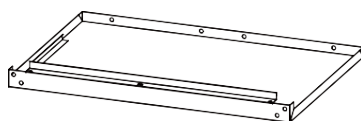

Toppanel, 1 stk.

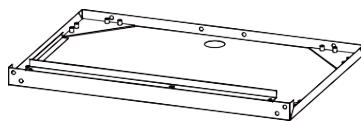

Bunnpanel, 1 stk.

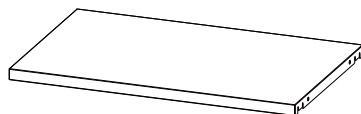

Hylle, 3 stk.

## TRINN 1

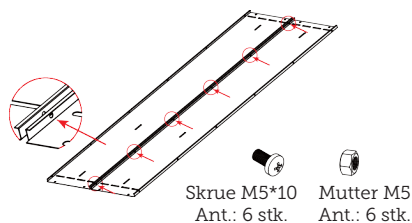

Legg de to bakplatene flatt og monter de sammen med skruer og muttere av typen M5\*10. Vær oppmerksom på at de øvre og nedre hullene endehullene er i samme posisjon.

## TRINN 2

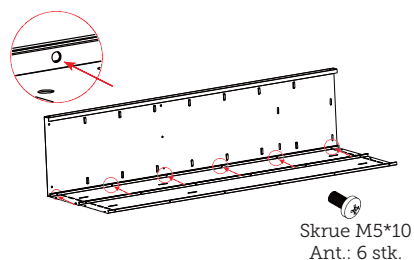

Plasser det venstre sidepanelet som vist, og koble det til bakplaten med skruer av typen M5\*10. Vær oppmerksom på plasseringen av de øvre og nedre hullene.

## TRINN 3

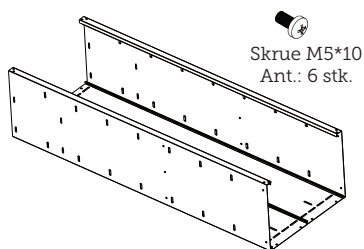

Monter høyre sidepanel i henhold til trinn 2. Vær oppmerksom på plasseringen av de øvre og nedre hullene, da de to sideplatene er symmetriske.

## TRINN 4

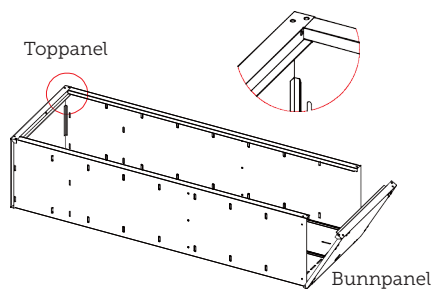

For å installere topp- og bunnpanelene, bør sidepanelene settes inn mellom de trekantede linjene på innsiden av topp- og bunnpanelene og sidene. Den ene enden av de fire runde hullene i sideplaten er den øvre kanten.

## TRINN 5

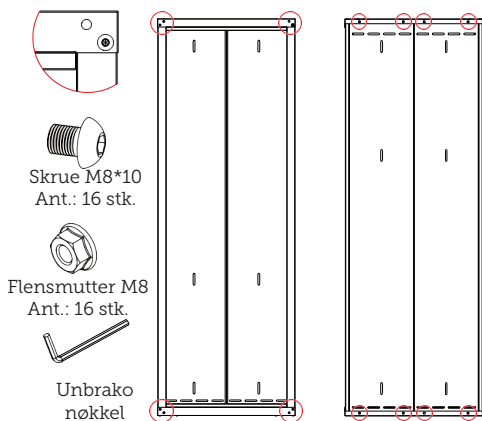

Skrue topp- og bunnpanelene til sidepanelene.

## TRINN 7

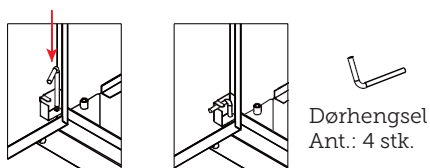

For å installere venstre dør, juster hullet til dørhengselet nederst på venstre dør med midten av skiven til dørhengsel på venstre side av bunnplaten, sett inn dørhengselet, og fest deretter dørhengselet på skiven til dørhengsel. Monter dørhengselet og høyre dør på samme måte.

## TRINN 6

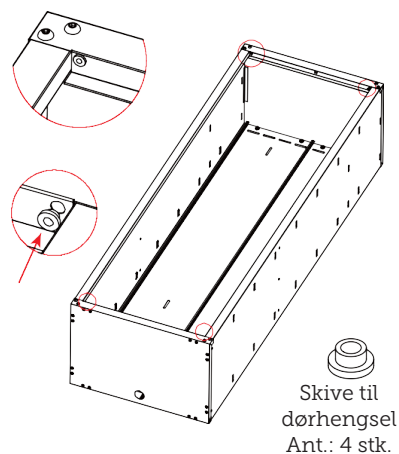

Monter skivene til dørhengselene i de fire hjørnene til topp- og bunnplatene.

## TRINN 8

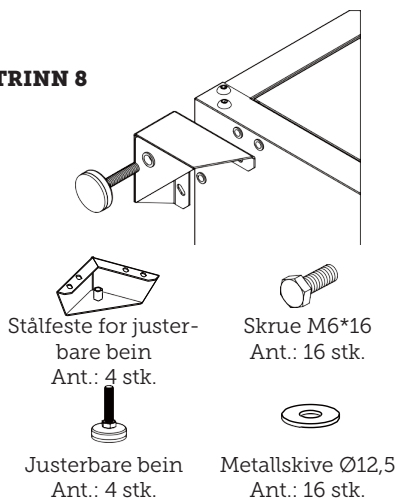

Skrue det justerbare beinet inn i stålfeste og bruk 4 stk. M6\*16-skruer til å feste det stålfeste til bunnplaten, slik at utsiden er på linje med bunnpanelet. Monter de andre tre føttene på samme måte.

## TRINN 9

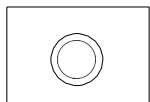
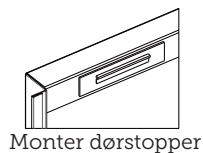

Monter gummiring

Gummien skal monteres på baksiden av bunnpanelet.

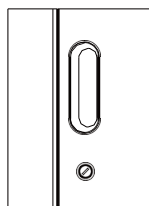

Monter håndtak



Dørstopper  
Ant.: 1 stk.



Håndtak  
Ant.: 1 stk.



Gummiring  
Ant.: 1 stk.

## TRINN 10

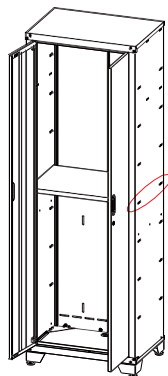

Reis opp skapet, monter en av hyllene midt i skapet (for å låse døren) og de to andre hyllene skal installeres der det er praktisk.

## Overskap BOX 2 og 3

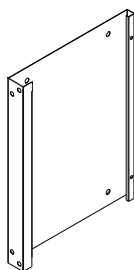

Sidepanel, 2 stk.

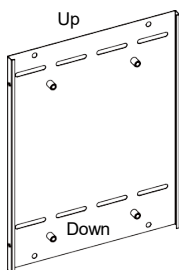

Bakplater, 2 stk.

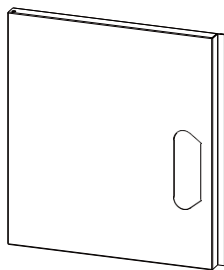

Venstre dør, 1 stk.

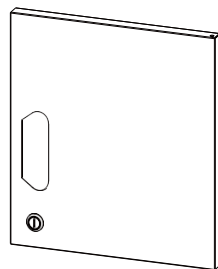

Høyre dør, 1 stk.

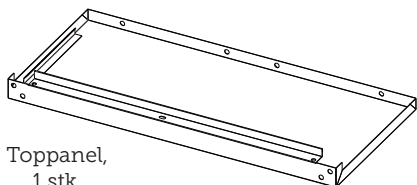

Toppanel,  
1 stk.

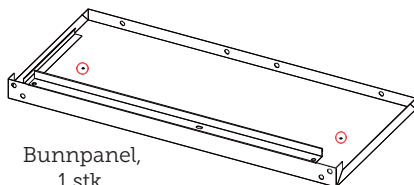

Bunnpanel,  
1 stk.



Installer overskapene på samme måte som høyskapet. Overskapene har ingen hyller og gummiringer, vennligst ignorer disse to elementene.

# Skap BOX 4

NO

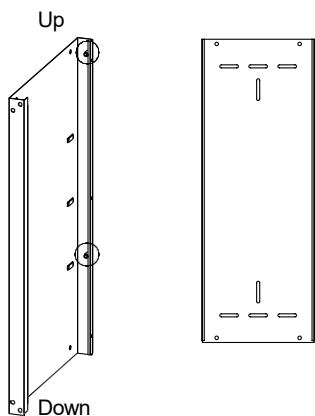

Venstre sidepanel, 1 stk.

Bakplate, 2 stk.

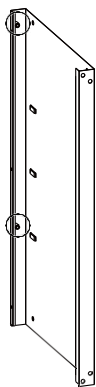

Høyre sidepanel, 1 stk.

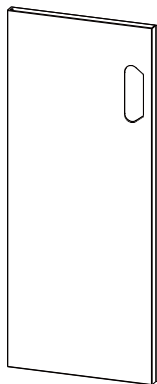

Venstre dør, 1 stk.

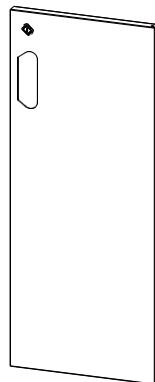

Høyre dør, 1 stk.

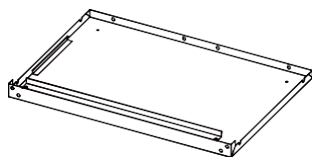

Toppanel, 1 stk.



Monter bunneskapet i henhold til instruksjonene for montering av høyskapet.



I trinn 2 og trinn 3 er sidepanelet og bakplate-  
ne kobles sammen med bolter og muttere.

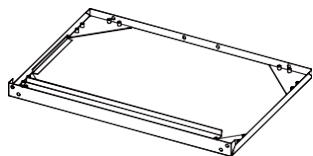

Bunnpanel, 1 stk.



Mutter M5  
Ant.: 9 stk.



Skrue M5\*10  
Ant.: 9 stk.



Trinn 10 Hyllen kan justeres etter ønske.

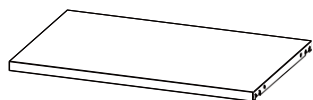

Hylle, 1 stk.

# Monteringshull

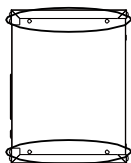
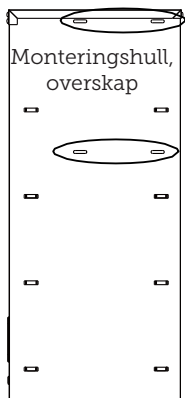

Overskap sett fra siden

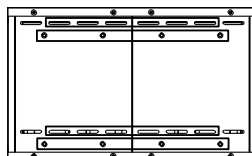

Overskap sett bakfra

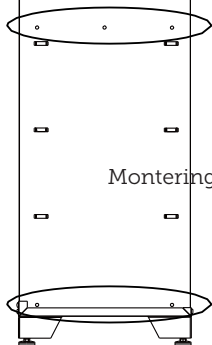

Høyskap sett bakfra

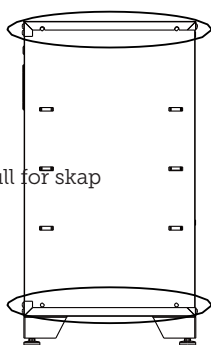

Skap sett fra siden

Monteringshull for skap

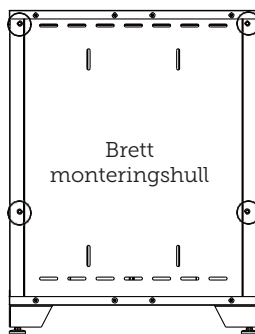

Skal sett bakfra

Monteringshull, benkeplate

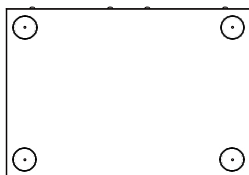

Skap sett ovenfra

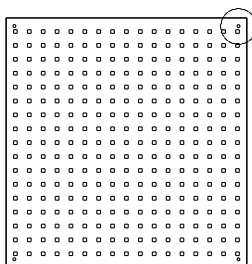

Verktøyplate

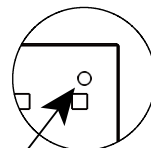

Monteringshull, veggskap

# Veggmontering

NO

## TRINN 1

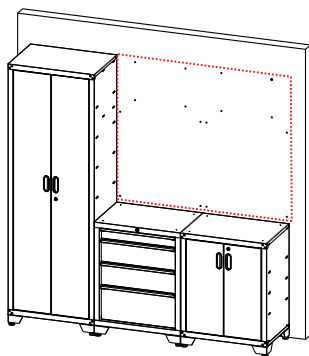

Veggplugg  
Ant.: 16 stk.

Planlegg plasseringen av verktøyskapet, bestem posisjonen til koblingshullet mellom verktøyplaten og overskapene, og fest deretter veggpluggen. Føttene til høyskapet og underskapet kan heves, og posisjonen til veggpluggen kan være litt høyere.

## TRINN 2

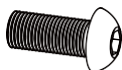

Skrue M8\*18  
Ant.: 8 stk.



Flensmutter M8  
Ant.: 4 stk.

Plasser høyskapet og overskapene på respektiv posisjon, og koble de sammen to og to. Det er montert nagler på sidepanelene til skuffeseksjonen, og det er ikke nødvendig med mutrer når du skal koble til de andre skapene.

## TRINN 3

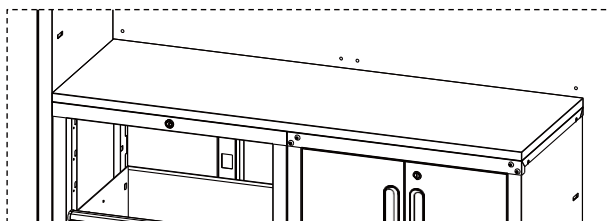

Selvgjengende  
skruer  
M5\*15  
Ant.: 8 stk.

Monter benkeplaten. Skru de selvgjengende skruene inn i benken gjennom monteringshullene på toppen av underskapet, og pass på at benkeplaten er på linje med utsiden av underskapet.

Ta ut alle nødvendige skuffer, og sett de tilbake igjen når alt er montert.

## TRINN 4

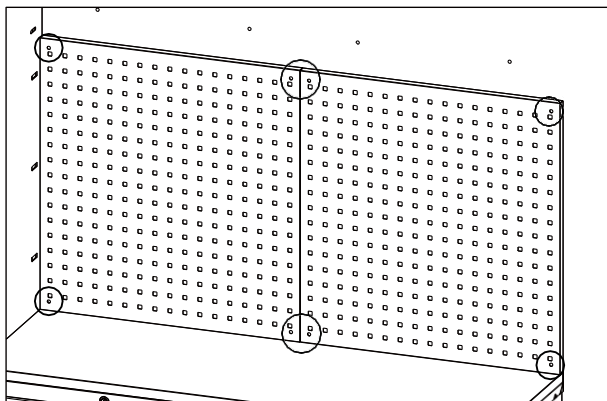

Treskrue M6\*60  
Ant.: 8 stk.



Metallskive Ø22,8  
Ant.: 8 stk.

Monter verktøyplaten. De store selvgjengende skruene må passere gjennom de runde hullene i de fire hjørnene på verktøyplaten og skru dem inn i veggpluggen på veggen for å feste verktøyplaten til veggen.

## TRINN 5

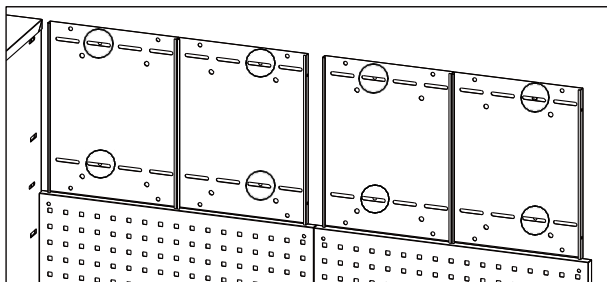

Treskrue M6\*60  
Ant.: 8 stk.



Metallskive Ø22,8  
Ant.: 8 stk.

For å montere skapet må du skru inn den store selvgjengende skruen inn gjennom hullet på bakplaten til overskapet for å feste det til veggen.

## TRINN 6

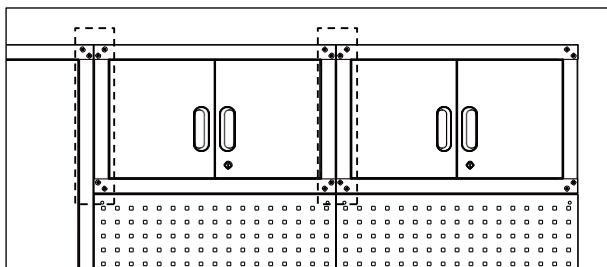

Skrue M8\*18  
Ant.: 8 stk.



Flensmutter M8  
Ant.: 8 stk.

Bolter og muttere brukes mellom overskapene og høyskapet.



---

**SERVICESENTRER**

Merk: Oppgi informasjon om produktets modellnummer ved alle henvendelser.

Modellnummeret vises foran på denne veiledningen samt på produktets merkeskilt.

*For:*

- Klager
  - Reservedeler
  - Returer
  - Garantihenvendelser
  - [www.schou.com](http://www.schou.com)
- 

Produsert i Kina

Produsent:

Schou Company A/S  
Nordager 31  
DK-6000 Kolding

Alle rettigheter forbeholdt. Innholdet i denne brukerveiledningen må ikke reproduseres, enten i sin helhet eller delvis, på noen som helst måte, elektronisk eller mekanisk, f.eks. kopiert eller publisert, oversatt eller lagret i et system for lagring og innhenting av informasjon, uten at det er innhentet en skriftlig tillatelse til dette fra Schou Company A/S.

---

# Garageförvaring

## INTRODUKTION

För att du ska få så stor glädje som möjligt av din nya produkt rekommenderar vi att du läser denna bruksanvisning innan du använder produkten. Vi rekommenderar dessutom att du sparar bruksanvisningen ifall du behöver läsa informationen om de olika funktionerna igen.

## TEKNISK INFORMATION

Skåp med 2 dörrar och 3 hyllor.  
66 x 45,7 x 198,1 cm. (B x D x H)

2 övre skåp med 2 dörrar vardera.  
66 x 30,5 x 40,6 cm. (B x D x H)

2 verktygspaneler med hål för krokar  
66 x 68,4 x 2 cm. (B x D x H)

Bänkskiva av massivt trä  
132 x 45,7 x 2,5 cm. (B x D x H)

Modul med 4 lådor  
66 x 45,7 x 86,4 cm. (B x D x H)

Skåp med 2 dörrar och en hylla.  
66 x 45,7 x 86,4 cm. (B x D x H)

## SÄRSKILDA SÄKERHETSANVISNINGAR

Garageförvaringsenheten måste stå upprätt och fästas på en bakre vägg. Enheten får inte stå fritt utan fästen.

Det rekommenderas att två personer flyttar och monterar skåpmöbeln. Underlåtenhet att följa detta kan det leda till ryggsador eller andra skador.

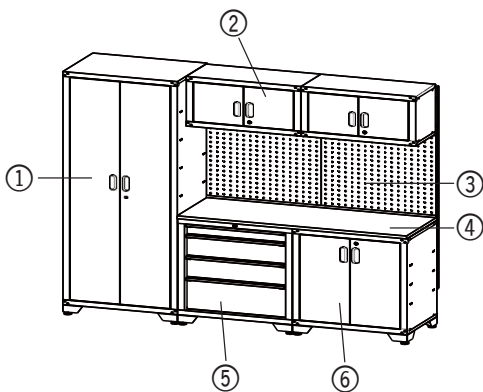

## DELAR AV GARAGEFÖRVARINGEN

1. Skåp med 2 dörrar och 3 hyllor
2. 2 övre skåp
3. 2 verktygspaneler
4. Bänkskiva
5. Modul med 4 lådor
6. Skåp med 2 dörrar och hylla

# Delar

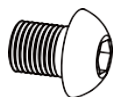

Skruv M8  
x 10

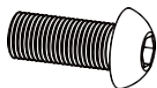

Skruv M8  
x 18



Flänsnutt  
M8



Skruv M5  
x 10

SE



Mutter  
M5



Träskruv M6 x 60

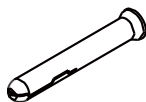

Väggplugg



Metallbricka Ø 22,8



Självgående skruv M5  
x 15

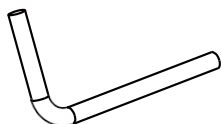

Dörr-  
gångjärn

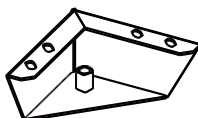

Höjjusterbara  
fötter i stål

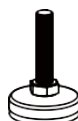

Gängad  
justerbar  
utjämnare

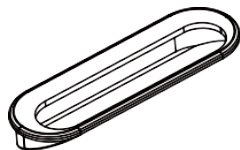

Handtag



Gummiring



Insex-  
nyckel



Skruv M6  
x 16



Metallbricka  
Ø 12,5



Dörr-  
gångjärns-  
bricka

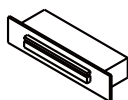

Dörrstopp



Nyckel

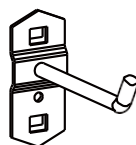

Krok

# Dellista

	Box1	Box2	Box3	Box4	Box5	Box6
Namn/Antal						
Skruv M8 x 10	16	16	16	16	0	0
Skruv M8 x 18	0	4	4	4	4	0
Flänsmutter M8	16	20	20	20	0	0
Skruv M5 x 10	18	6	6	9	0	0
Mutter M5	6	2	2	9	0	0
Skruv M6 x 16	16	0	0	16	16	0
Metallbricka Ø 12,5	16	0	0	16	16	0
Träskruv M6 x 60	0	4	4	0	8	0
Väggplugg	0	4	4	0	8	0
Metallbricka Ø 22,8	0	4	4	0	8	0
Självgående skruv M5 x 15	0	0	0	4	4	0
Dörrgångjärn	4	4	4	4	0	0
Dörrgångjärnsbricka	4	4	4	4	0	0
Höjdstjerbara fötter i stål	4	0	0	4	4	0
Gängad justerbar utjämnare	4	0	0	4	4	0
Handtag	2	2	2	2	0	0
Dörrstopp	4	4	4	4	0	0
Gummiring	1	0	0	0	0	0
Insexnyckel	0	0	0	0	1	0
Nyckel	2	2	2	2	2	0
Krok	0	0	0	0	10	0

# Montering

## Högt förvaringskåp BOX1

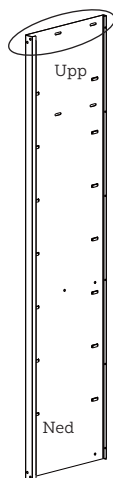

Vänster  
sidopanel 1 st



Bakpanel  
2 st

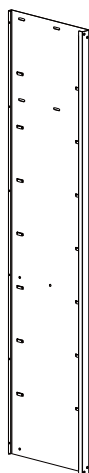

Höger sidopanel  
1 st

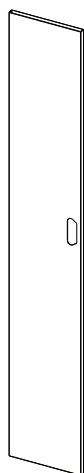

Vänster  
dörr 1 st

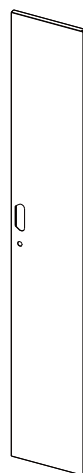

Höger dörr  
1 st

SE

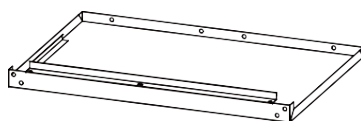

Övre panel 1 st

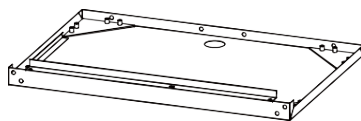

Bottenpanel 1 st

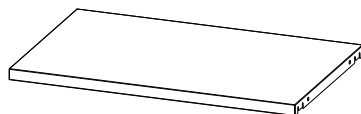

Hylla 3 st

### STEG 1

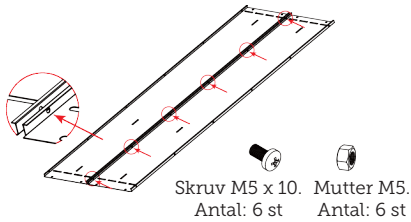

Lägg de två bakpanelerna plant och anslut dem med M5 x 10-skrivar och muttrar. Tänk på att de övre och nedre hålen ska vara i samma position.

### STEG 2

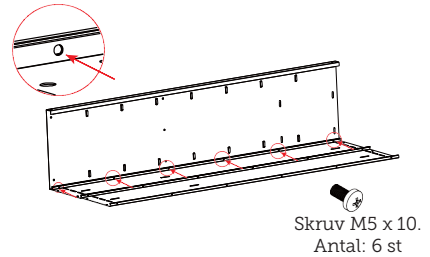

Placera den vänstra panelen enligt bilden och anslut den till den bakre panelen med M5 x 10-skrivar. Var uppmärksam på placeringen av de övre och nedre hålen.

### STEG 3

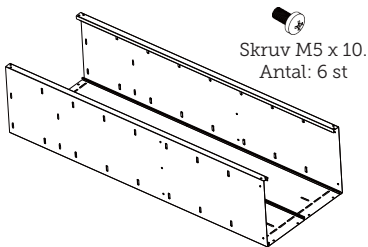

Montera höger sidopanel enligt det andra steget. Var uppmärksam på placeringen av de övre och nedre hålen, de två sidoplattorna är symmetriska.

### STEG 4

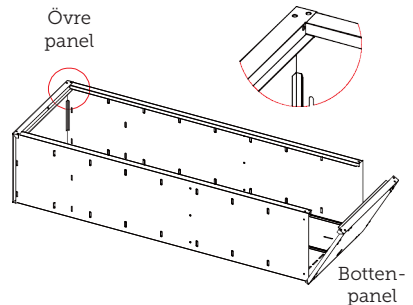

För att montera den övre panelen och bottenpanelen, ska sidopanelerna föras in mellan de triangulära linjerna på insidan av den övre panelen och bottenpanelen och på sidorna. Sidan med de fyra runda hålen på sidoplattan är den övre änden.

## STEG 5

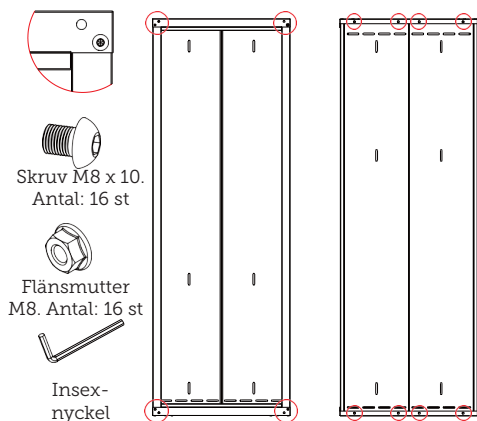

Skruva fast den övre panelen och bottenpanelen på sidobakpanelerna.

## STEG 7

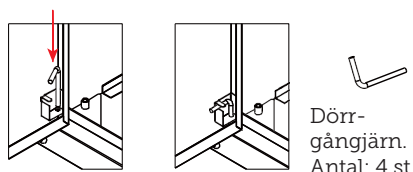

För att montera vänster dörr, rikta in dörrgängjärnshålet vid botten av vänster dörr mot mitten av dörrgängjärnsbrickan på vänster sida av bottenpanelen. För in dörrgängjärnet och fäst sedan dörrgängjärnet på dörrgängjärnsbrickan. Montera dörrgängjärnet och höger dörr på samma sätt.

## STEG 6

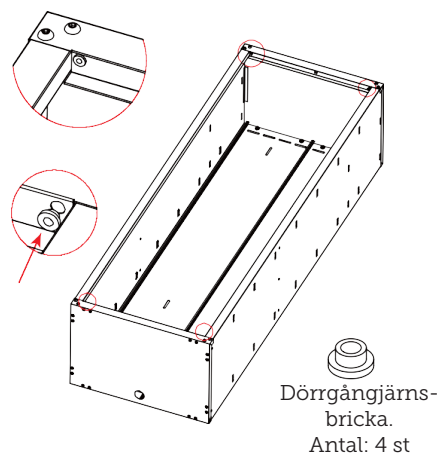

Montera dörrgängjärnsbrickan på de fyra hörnen av den övre panelen och bottenpanelen.

## STEG 8

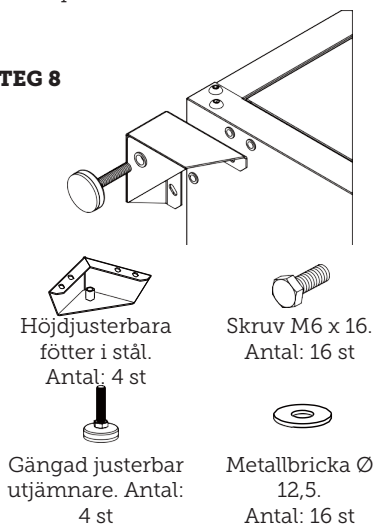

Skruva in den gängade justerbara utjämnaren i botten av den höjddjusterbara foten i stål och använd 4 M6 x 16-skrivar för att fästa den höjddjusterbara foten i stål på bottenpanelen, så att den yttre sidan är i linje med bottenpanelen. Montera de andra tre fötterna på samma sätt.

## STEG 9

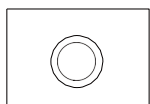
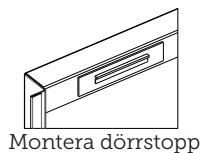

Montera gummiring

Gummiringen monteras på baksidan av bottenpanelen.

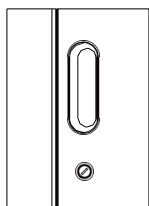

Dörrstopp.  
Antal: 1 st



Handtag.  
Antal: 1 st



Gummiring.  
Antal: 1 st

## STEG 10

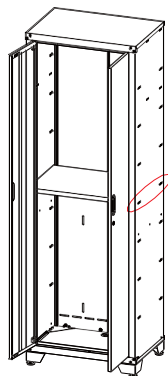

Ställ upp skåpet, montera en av hyllorna i mitten av skåpet (för att låsa dörren), och montera de andra två hyllorna där det är lämpligt.

## Överskåp BOX 2 och 3

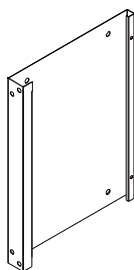

Sidopanel 2 st

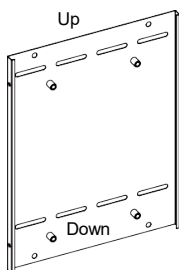

Bakpanel 2 st

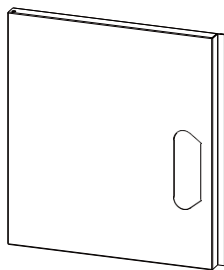

Vänster dörr  
1 st

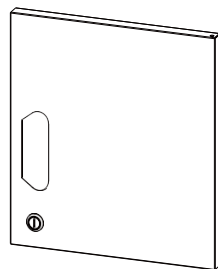

Höger dörr 1 st

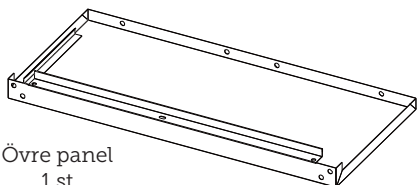

Övre panel  
1 st

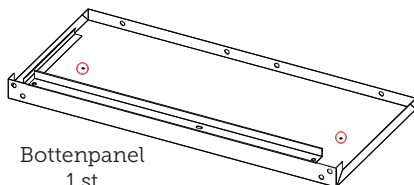

Bottenpanel  
1 st



Montera de övre skåpen precis som det höga skåpet. Det övre skåpet har inga hyllor och gummiringar, ignorera dessa två föremål.



# Skåp BOX 4

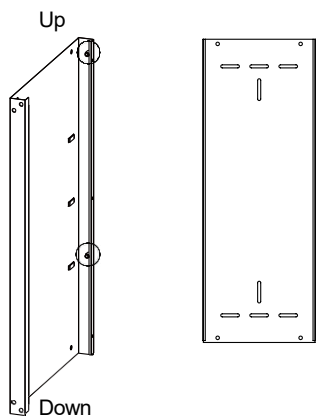

Vänster sidopanel 1 st

Bakpanel 2 st

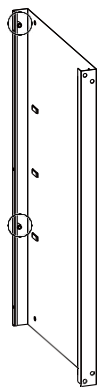

Höger sidopanel 1 st

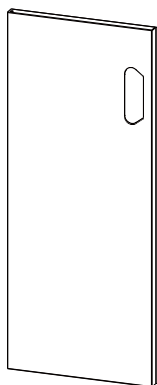

Vänster dörr 1 st

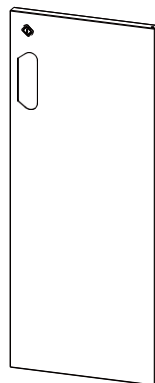

Höger dörr 1 st

SE

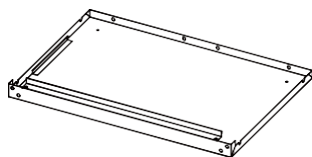

Övre panel 1 st



Montera underskåpet enligt monteringsanvisningarna för det höga skåpet.



I steg 2 och 3 är sidopanelen och bakpanelen sammanfogade med bultar och muttrar.

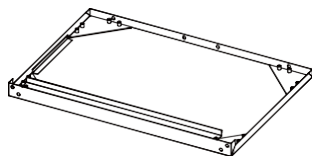

Bottenpanel 1 st



Mutter M5.  
Antal: 9 st



Skruv M5 x 10.  
Antal: 9 st



Steg 10. Justera hyllan efter behov.

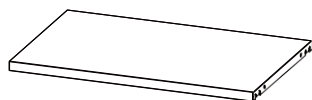

Hylla 1 st

# Anslutningshål

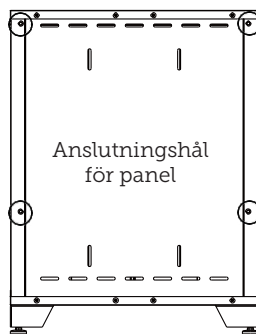
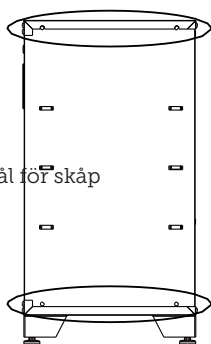
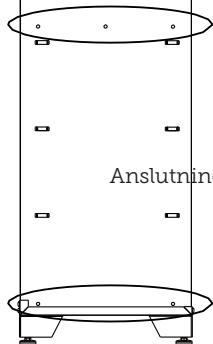
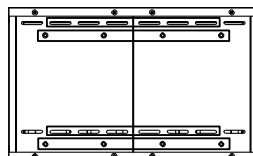
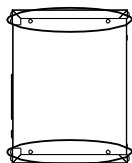

Anslutningshål för skåp

Anslutningshål för panel

Anslutningshål för bänkskiva

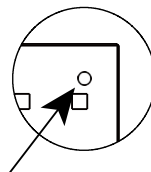
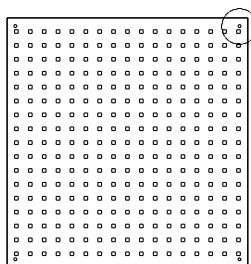

# Montera på väggen

## STEG 1

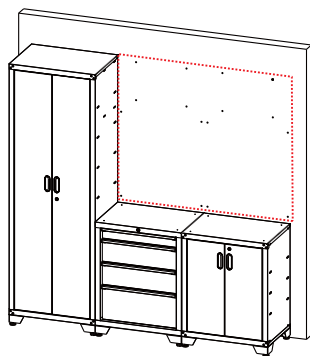

Väggplugg  
Antal: 16 st

SE

Planera placeringen av verktygsskåpet, bestäm positionen för anslutningshålet mellan verktygspanelen och det övre skåpet, fäst sedan väggpluggen. Du kan höja fötterna på det höga skåpet och underskåpet och placera väggpluggen något högre.

## STEG 2

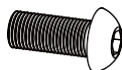

Skruv M8 x 18.  
Antal: 8 st



Flänsmutter M8.  
Antal: 4 st

Placera de höga skåpen och de övre skåpen i sina respektive positioner, rikta in dem och anslut dem parvis. Nitmuttrar har installerats på sidopanelerna på lådskåpet, det finns inget behov av att använda muttrarna vid anslutning av andra skåp.

## STEG 3

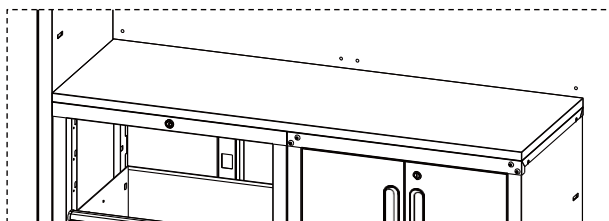

Självgående skruv  
M5 x 15.  
Antal: 8 st

Montera bänkskivan. Skruva in de självgående skruvarna i bänkskivan genom monteringshålen på skåpets ovsida och se till att bänkskivan är i linje med underskåpets utsida.

Ta bort fler lådor vid behov och sätt slutligen tillbaka lådorna på plats.

## STEG 4

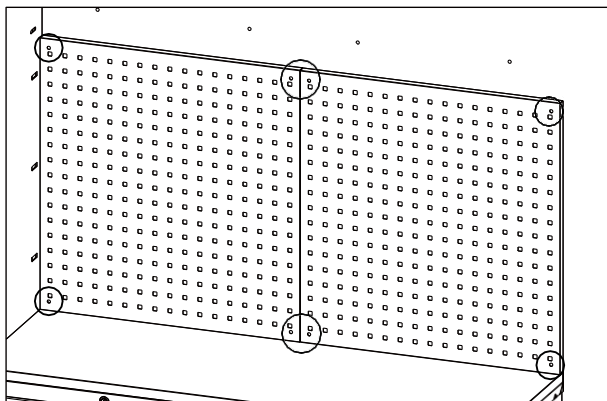

Montera verktygspanelen. De stora självgängande skruvarna måste passera genom de runda hålen i verktygspanelens fyra hörn och skruvas in i väggpluggen för att fästa verktygspanelen i väggen.



Träskruv M6 x 60.  
Antal: 8 st



Metallbricka  $\text{Ø}$  22,8.  
Antal: 8 st

## STEG 5

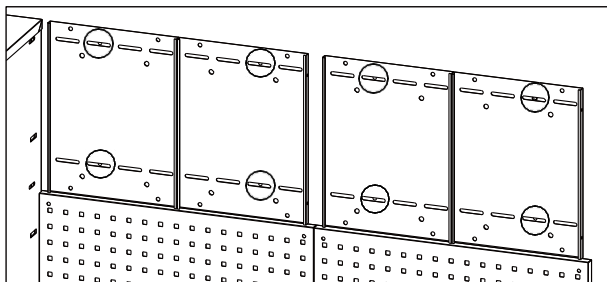

För att installera skåpet, skruva in den stora självgängande skruven genom hålet på skåpets baksida i väggpluggen för att fästa skåpet.



Träskruv M6 x 60.  
Antal: 8 st



Metallbricka  $\text{Ø}$  22,8.  
Antal: 8 st

## STEG 6

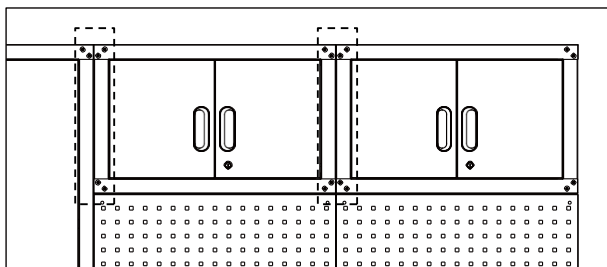

Bultar och muttrar används mellan de övre skåpen och det höga skåpet.



Skruv M8 x 18.  
Antal: 8 st



Flänsmutter M8.  
Antal: 8 st

---

**SERVICEVERKSTAD**

Observera: Kom ihåg att ange produktens modellnummer om du har frågor.

Modellnumret står längst fram i den här manualen och på produktens märkskylt.

*För:*

- Klagomål
  - Reservdelar
  - Returneringar
  - Garantiärenden
  - [www.schou.com](http://www.schou.com)
- 

Tillverkad i Kina

Tillverkare:

Schou Company A/S  
Nordager 31  
DK-6000 Kolding

Alla rättigheter förbehållna. Innehållet i den här bruksanvisningen får inte återskapas, varken helt eller delvis, på något sätt med elektroniska eller mekaniska medel, t.ex. kopiering eller publicering, översättas eller sparas i ett system för informationslagring och -hämtning utan skriftligt godkännande från Schou Company A/S.

---

# Autotallin kalusteryhmä

## JOHDANTO

Saat uudesta tuotteestasi suurimman hyödyn, kun luet tämän käyttöohjeen läpi ennen tuotteen käyttöönottoa. Säilytä tämä käyttöohje, jotta voit tarvittaessa palauttaa mieleesi tuotteen toiminnot.

## TEKNISET TIEDOT

Kaappi, jossa on 2 ovea ja 3 hyllyä.  
66 x 45,7 x 198,1 cm. (LxSxK)

2 yläkaappia, joissa kummassakin 2 ovea.  
66 x 30,5 x 40,6 cm. (LxSxK)

2 reikälevyä, joissa reiät koukuille  
66 x 68,4 x 2 cm. (LxSxK)

Massiivipuinen pöytälevy  
132 x 45,7 x 2,5 cm. (LxSxK)

Moduuli, jossa 4 vetolaatikkoa  
66 x 45,7 x 86,4 cm. (LxSxK)

Kaappi, jossa 2 ovea ja hylly.  
66 x 45,7 x 86,4 cm. (LxSxK)

## TURVALLISUUSOHJEET

Autotallin kalusteryhmän tulee olla pystysuorassa ja se tulee kiinnittää takaseinään. Sitä ei saa jättää kiinnittämättä!

Suosittellemme, että kaapin siirtämiseen, kokoamiseen ja asentamiseen osallistuu kaksi henkilöä. Jos näin ei toimita, seurauksena voi olla selkä- tai muita vammoja.

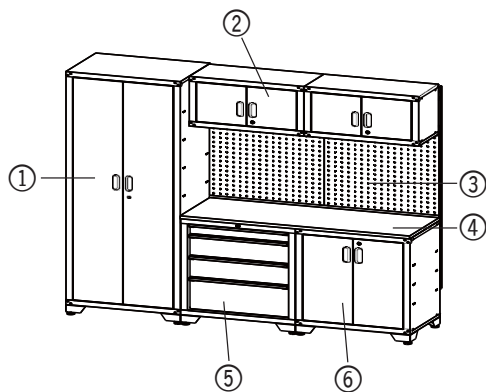

## AUTOTALLIN KALUSTERYHMÄN OSAT

1. Kaappi, jossa 2 ovea ja 3 hyllyä
2. 2 yläkaappia
3. 2 reikälevyä
4. Pöytälevy
5. Moduuli, jossa 4 vetolaatikkoa
6. Kaappi, jossa 2 ovea ja hylly

# Osat

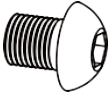

Ruuvi M8\*10

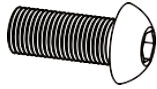

Ruuvi M8\*18



Laippamutteri  
M8



Ruuvi M5\*10



Mutteri  
M5



Puuruuvi M6\*60

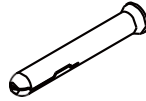

Seinätulppa



Metallinen aluslevy  
Ø22,8

FI



Itsekierteittävä ruuvi  
M5\*15

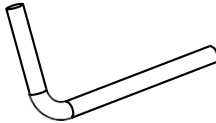

Ovisarana

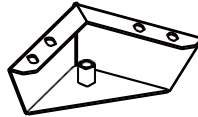

Teräksinen  
kalustejalca



Kierteitetty säätö-  
jalka



Kahva



Kumirengas



Kuusiok-  
oloavain

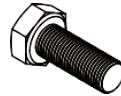

Ruuvi M6\*16



Metallinen  
aluslevy Ø12,5



Ovisaranan  
aluslevy

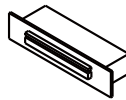

Ovistoppari

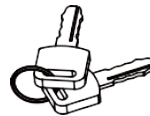

Avain

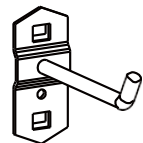

Koukku

# Osaluettelo

	Laatik-ko1	Laatik-ko2	Laatik-ko3	Laatik-ko4	Laatik-ko5	Laatik-ko6
Nimi/määrä						
Ruuvi M8*10	16	16	16	16	0	0
Ruuvi M8*18	0	4	4	4	4	0
Laippamutteri M8	16	20	20	20	0	0
Ruuvi M5*10	18	6	6	9	0	0
Mutteri M5	6	2	2	9	0	0
Ruuvi M6*16	16	0	0	16	16	0
Metallinen aluslevy Ø12,5	16	0	0	16	16	0
Puuruuvi M6*60	0	4	4	0	8	0
Seinätulppa	0	4	4	0	8	0
Metallinen aluslevy Ø22,8	0	4	4	0	8	0
Itsekierteittävä ruuvi M5*15	0	0	0	4	4	0
Ovisarana	4	4	4	4	0	0
Ovisaranan aluslevy	4	4	4	4	0	0
Teräksinen kalustejalca	4	0	0	4	4	0
Kierteitetty säätöjalca	4	0	0	4	4	0
Kahva	2	2	2	2	0	0
Ovistoppari	4	4	4	4	0	0
Kumirengas	1	0	0	0	0	0
Kuusiokoloavain	0	0	0	0	1	0
Avain	2	2	2	2	2	0
Koukku	0	0	0	0	10	0



# Kokoaminen

## Korkea kaappi LAATIKKO1

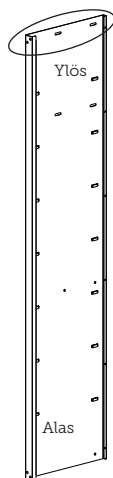

Vasen sivupaneeli 1 KPL



Takapaneeli 2 KPL

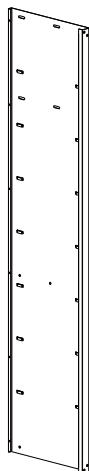

Oikea sivupaneeli 1 KPL

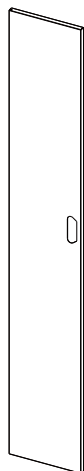

Vasen ovi 1 KPL

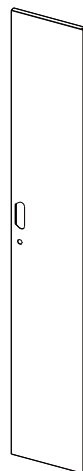

Oikea ovi 1 KPL

FI

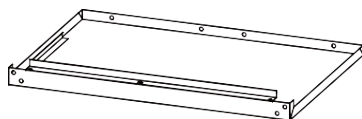

Yläpaneeli 1 KPL

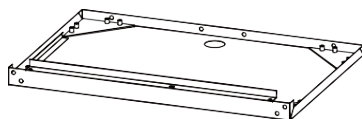

Alapaneeli 1 KPL

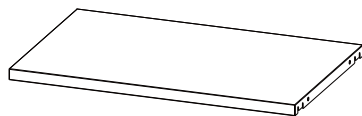

Hylly 3 KPL

## 1. VAIHE

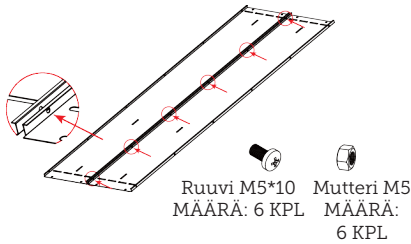

Aseta kaksi takapaneelia tasaiselle alustalle ja yhdistä ne M5\*10-ruuveilla ja muttereilla. Varmista, että ylä- ja alaosan reiät ovat samassa kohdassa.

## 2. VAIHE

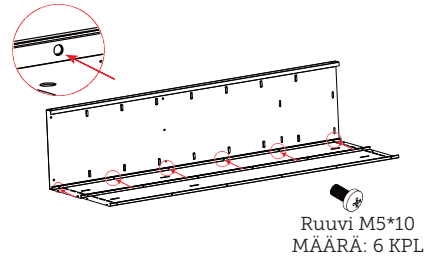

Aseta vasen paneeli kuvan mukaisesti ja kiinnitä se takapaneeliin M5\*10-ruuveilla. Kiinnitä huomiota ylä- ja alaosan reikiin sijaintiin.

## 3. VAIHE

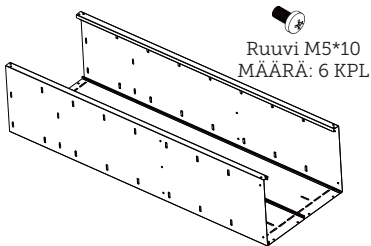

Asenna oikea sivupaneeli toisen vaiheen mukaisesti. Kiinnitä huomiota ylä- ja alaosan reikiin sijaintiin. Sivulevyt ovat symmetrisiä.

## 4. VAIHE

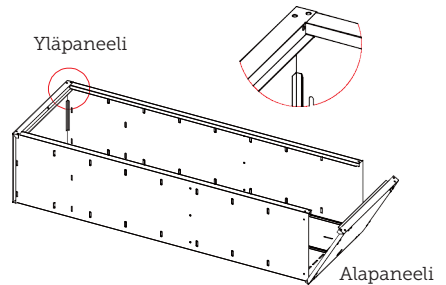

Ylä- ja alapaneelien asentamista varten sivupaneelit on työnnettävä ylä- ja alapaneelien ja sivujen sisäpuolella olevien kolmiomaisten viivojen väliin. Sivulevyn neljän pyöreän reiän toinen pää on yläpää.

## 5. VAIHE

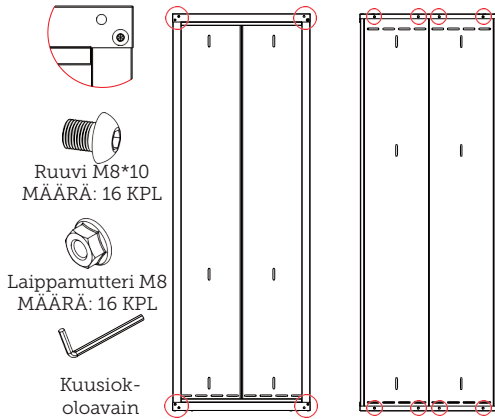

Ruuvi M8\*10  
MÄÄRÄ: 16 KPL

Laippamutteri M8  
MÄÄRÄ: 16 KPL

Kuusiok-  
oloavain

Kiinnitä ylä- ja alapaneelit ruuveilla sivutakapaneeleihin.

## 6. VAIHE

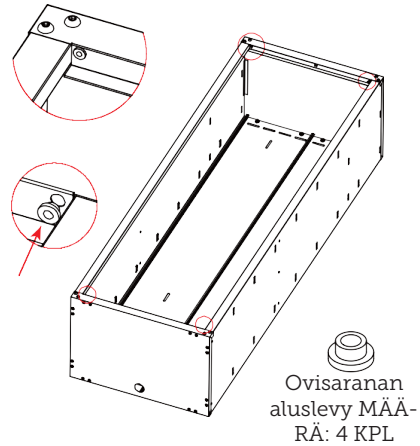

Ovisaranan  
aluslevy MÄÄ-  
RÄ: 4 KPL

Asenna ovisaranan aluslevy ylä- ja alalevyn neljään kulmaan.

## 7. VAIHE

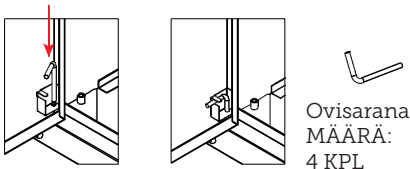

Ovisarana  
MÄÄRÄ:  
4 KPL

Asenna vasen ovi kohdistamalla vasemman oven alareunassa oleva ovisaranan reikä pohjalevyn vasemmalla puolella olevan ovisaranan aluslevyn keskikohtaan, aseta ovisarana paikalleen ja kiinnitä sitten ovisarana ovisaranan aluslevyyn. Asenna ovisarana ja oikea ovi samalla tavalla.

## 8. VAIHE

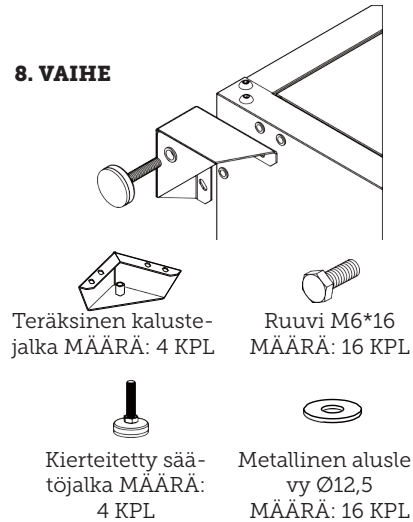

Teräksinen kaluste-  
jalka MÄÄRÄ: 4 KPL

Ruuvi M6\*16  
MÄÄRÄ: 16 KPL

Kierteitetty sää-  
töjalka MÄÄRÄ:  
4 KPL

Metallinen alusle-  
vy Ø12,5  
MÄÄRÄ: 16 KPL

Ruuvaa kierteitetty säätöjalka teräksisen kalustejalan pohjaan ja kiinnitä teräksinen kalustejalka 4 M6\*16-ruuvilla alapaneelin pohjaan siten, että ulompi puoli on samassa linjassa alapaneelin kanssa. Asenna kolme muuta jalkaa samalla tavalla.

## 9. VAIHE

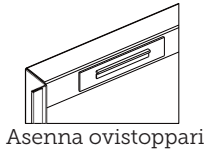

Kumi asennetaan alapaneelin ta-  
kaosaan.



Ovistoppari MÄÄRÄ: 1 KPL  
Kahva MÄÄRÄ: 1 KPL  
Kumirengas MÄÄRÄ: 1 KPL

## 10. VAIHE

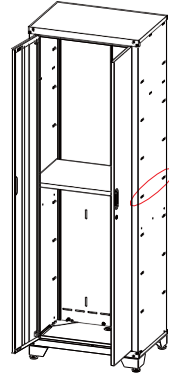

Nosta kaappi pystyyn, asenna yksi  
hyllyistä kaapin keskelle (oven lukit-  
semista varten), ja kaksi muuta hyllyä  
haluamallesi korkeudelle.

## Yläkaapit LAATIKKO 2 & 3

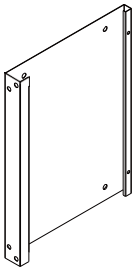

Sivupaneeli  
2 KPL

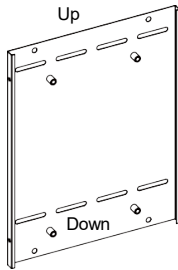

Takapaneeli  
2 KPL

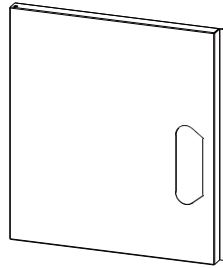

Vasen ovi  
1 KPL

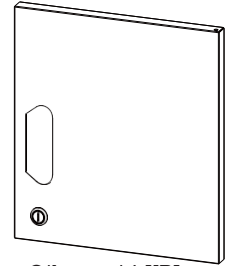

Oikea ovi 1 KPL

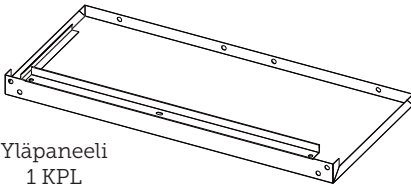

Yläpaneeli  
1 KPL

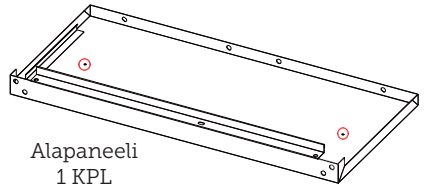

Alapaneeli  
1 KPL



Asenna yläkaapit samalla tavalla kuin korkea kaappi. Yläkaapissa ei ole hyllyjä eikä kumirenkaita, joten jätä nämä kaksi kohtaa huomiotta.

# Kaappi LAATIKKO 4

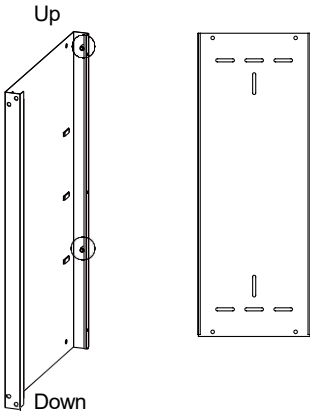

Vasen sivupaneeli  
1 KPL

Takapaneeli  
2 KPL

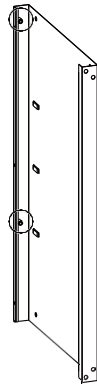

Oikea sivupaneeli  
1 KPL

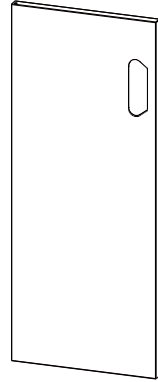

Vasen ovi  
1 KPL

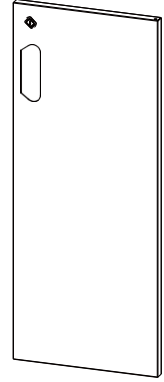

Oikea ovi 1  
KPL

FI

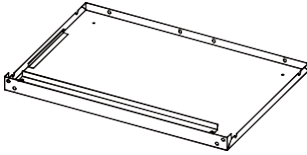

Yläpaneeli 1 KPL



Asenna alakaappi korkean kaapin asennusohjeiden mukaisesti.



Vaiheissa 2 ja 3 sivupaneeli ja takapaneeli liitetään toisiinsa pulteilla ja muttereilla.



Mutteri M5  
MÄÄRÄ: 9 KPL



Ruuvi M5\*10  
MÄÄRÄ: 9 KPL

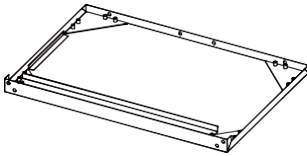

Alapaneeli 1 KPL



Säädä hyllyä halutessasi 10. vaiheessa.

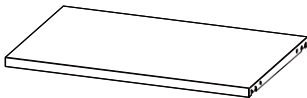

Hylly 1 KPL

# Kiinnitysreiät

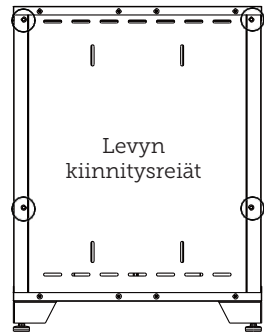
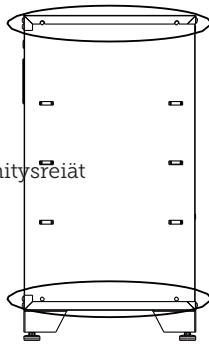
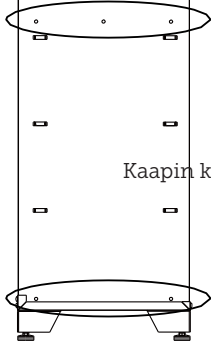
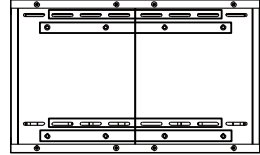
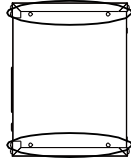
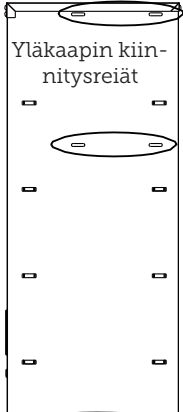

Pöytätason kiinnitysreiät

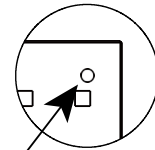
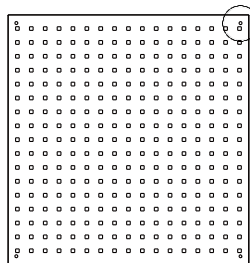

# Kiinnittäminen seinään

## 1. VAIHE

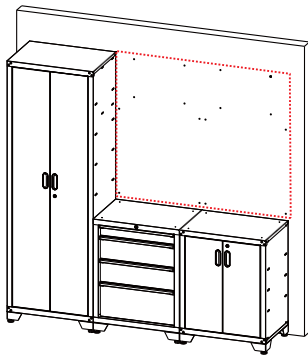

Seinätulppa  
MÄÄRÄ: 16 KPL

FI

Valitse työkalukaapin paikka, määritä pöytäta-son ja yläkaapin välisen kiinnitysreiän sijainti ja kiinnitä sitten seinätulppa. Korkean kaapin ja alakaapin jalvoja voi korottaa, ja seinätulppa voi olla hieman korkeammalla.

## 2. VAIHE

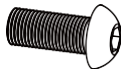

Ruuvi M8\*18  
MÄÄRÄ: 8 KPL



Laippamutteri M8  
MÄÄRÄ: 4 KPL

Järjestä korkeat ja yläkaapit omille paikoilleen, kohdista ne ja liitä ne pareittain. Vetolaatikoilla varustetun kaapin sivupaneeleihin on asennettu niittimutterit, joten muttereita ei tarvitse käyttää muiden kaappien liittämiseen.

## 3. VAIHE

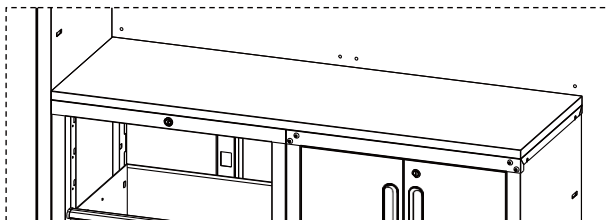

Itsekierteittävä ruuvi  
M5\*15  
MÄÄRÄ: 8 KPL

Asenna pöytälevy. Kierrä itsekierteittävät ruuvit pöytälevvyyn kaapin yläosassa olevien kiinnitysreikien kautta ja varmista, että pöytälevy on samassa linjassa alakäapin ulkopinnan kanssa. Irrota tarvittaessa lisää vetolaatikoita ja asenna lopuksi vetolaatikat takaisin paikoilleen.

#### 4. VAIHE

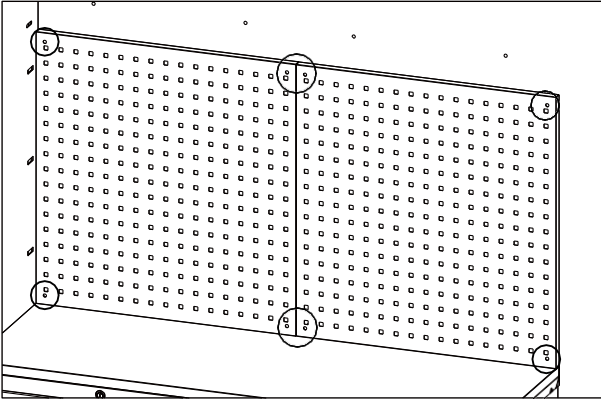

Puuruuvi M6\*60  
MÄÄRÄ: 8 KPL



Metallinen aluslevy Ø22,8  
MÄÄRÄ: 8 KPL

Asenna reikälevy. Kiinnitä reikälevy seinään kiertämällä suuret itsekierteittävät ruuvit reikälevyn neljässä kulmassa olevien pyöreiden reikien läpi seinässä olevaan seinätulppaan.

#### 5. VAIHE

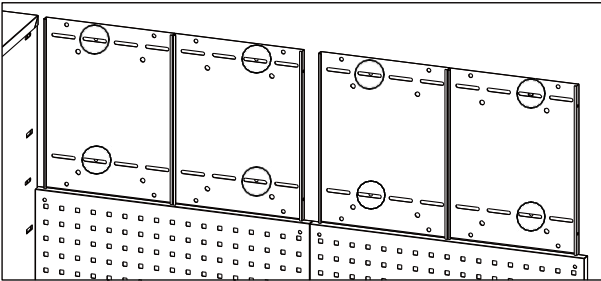

Puuruuvi M6\*60  
MÄÄRÄ: 8 KPL



Metallinen aluslevy Ø22,8  
MÄÄRÄ: 8 KPL

Kiinnitä kaappi kiertämällä suuri itsekierteittävä ruuvi seinäkaapin takapaneelissa olevan reiän läpi seinätulppaan.

#### 6. VAIHE

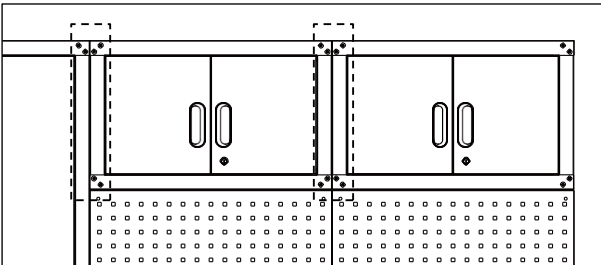

Ruuvi M8\*18  
MÄÄRÄ: 8 KPL



Laippamutteri M8  
MÄÄRÄ: 8 KPL

Yläkaappien ja korkean kaapin välissä käytetään pultteja ja muttereita.



---

**ASIAKASPALVELU**

Huomautus: Ilmoita tuotteen mallinumero kaikissa yhteydenotoissa.

Mallinumeron löydät tämän ohjekirjan etusivulta ja tuotteen arvokilvestä.

*Ota yhteyttä seuraavissa asioissa:*

- Valitukset
  - Vaihto-osat
  - Palautukset
  - Takuuasiat
  - [www.schou.com](http://www.schou.com)
- 

Valmistettu Kiinassa

Valmistaja:

Schou Company A/S  
Nordager 31  
DK-6000 Kolding

Kaikki oikeudet pidätetään. Tämän käyttöohjeen sisältöä ei saa jäljentää kokonaan tai osittain millään elektronisella tai mekaanisella tavalla, esim. kopioidulla tai julkaisemalla, kääntää tai tallentaa tietojen tallennus- ja hakujärjestelmiin, ilman Schou Company A/S:n kirjallista lupaa.

---

# Garage Storage

## INTRODUCTION

To get the most out of your new product, please read this manual before use. Please also save the manual in case you need to refer to it at a later date.

## TECHNICAL DATA

Cabinet with 2 doors and 3 shelves.  
66 x 45,7 x 198,1 cm. (WxDxH)

2 upper cabinets with 2 doors each.  
66 x 30,5 x 40,6 cm. (WxDxH)

2 tool boards with holes for hooks  
66 x 68,4 x 2 cm. (WxD)

Benchtop made from solid wood  
132 x 45,7 x 2,5 cm. (WxDxH)

Module with 4 drawers  
66 x 45,7 x 86,4 cm. (WxDxH)

Cabinet with 2 doors and shelf.  
66 x 45,7 x 86,4 cm. (WxDxH)

## SPECIAL SAFETY INSTRUCTIONS

The garage storage must stand upright and be secured to a rear wall. It must not be left to stand freely!

It is recommended that two people move, assemble, and mount the cabinet furniture. Failure to do so can result in back or other injury.

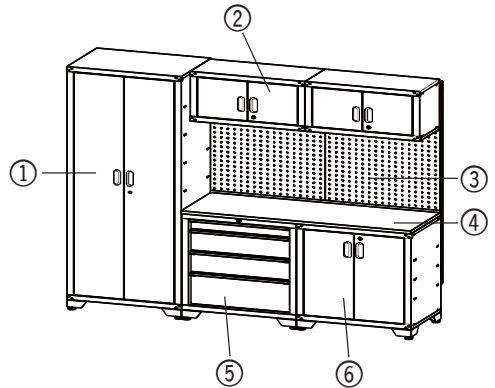

## PARTS OF THE GARAGE STORAGE

1. Cabinet with 2 doors and 3 shelves
2. 2 upper cabinets
3. 2 tool boards
4. Benchtop
5. Module with 4 drawers
6. Cabinet with 2 doors and shelf

# Parts

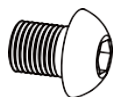

Screw M8\*10

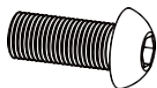

Screw M8\*18



Flange nut M8



Screw M5\*10



Nut M5



Wood screw M6\*60

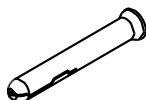

Wall plug



Metal washer Ø22.8

GB



Self-tapping screw M5\*15

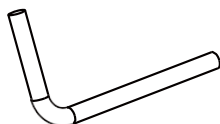

Door hinge

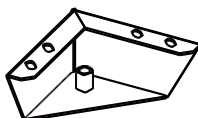

Steel leveling leg

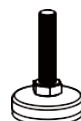

Threaded adjustable leveler

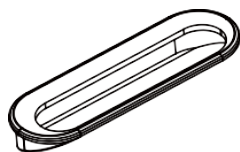

Handle



Rubber ring



Allen key

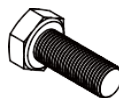

Screw M6\*16



Metal washer  
Ø12.5



Door hinge  
washer

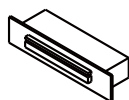

Door stopper



Key

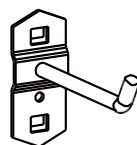

Hook

# Parts List

	Box1	Box2	Box3	Box4	Box5	Box6
Name / Quantity						
Screw M8*10	16	16	16	16	0	0
Screw M8*18	0	4	4	4	4	0
Flange nut M8	16	20	20	20	0	0
Screw M5*10	18	6	6	9	0	0
Nut M5	6	2	2	9	0	0
Screw M6*16	16	0	0	16	16	0
Metal Washer Ø12.5	16	0	0	16	16	0
Wood screw M6*60	0	4	4	0	8	0
Wall plug	0	4	4	0	8	0
Metal Washer Ø22.8	0	4	4	0	8	0
Self-tapping screw M5*15	0	0	0	4	4	0
Door Hinge	4	4	4	4	0	0
Door Hinge Washer	4	4	4	4	0	0
Steel Leveling Leg	4	0	0	4	4	0
Threaded Adjusta- ble Leveler	4	0	0	4	4	0
Handle	2	2	2	2	0	0
Door Stopper	4	4	4	4	0	0
Rubber ring	1	0	0	0	0	0
Allen key	0	0	0	0	1	0
Key	2	2	2	2	2	0
Hook	0	0	0	0	10	0

# Assembly

## Tall storage cabinet BOX1

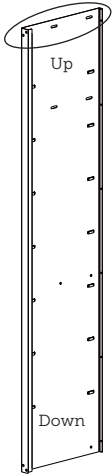

Left Side Panel  
1 PCS



Back Panel  
2 PCS

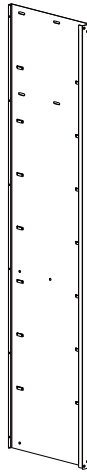

Right Side Panel  
1 PCS

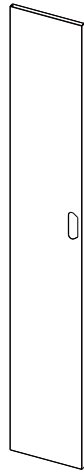

Left Door  
1 PCS

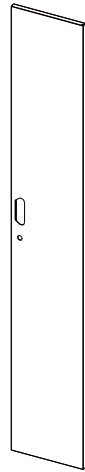

Right Door  
1 PCS

GB

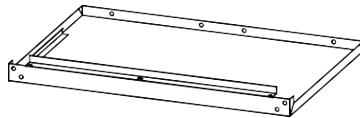

Top Panel 1 PCS

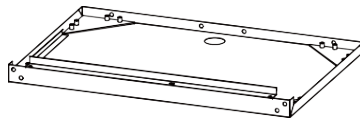

Bottom Panel 1 PCS



Shelf 3 PCS

### STEP 1

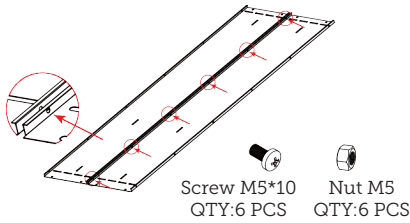

Lay the two back panels flat and connect them with M5\*10 screws and nuts. Note that the upper and lower end holes are in the same position.

### STEP 2

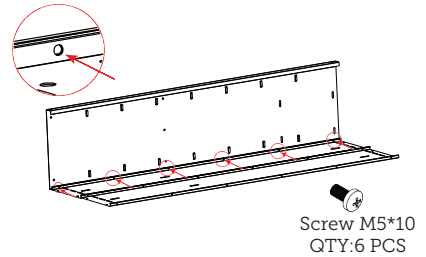

Place the left panel as shown, and connect it with the back panel with M5\*10 screws. Pay attention to the position of the upper and lower end holes.

### STEP 3

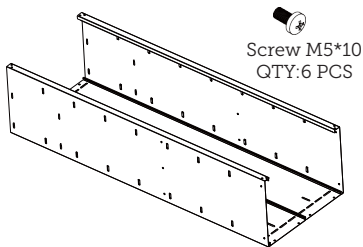

Install the right side panel according to the second step. Pay attention to the position of the upper and lower end holes, the two side plates are symmetrical.

### STEP 4

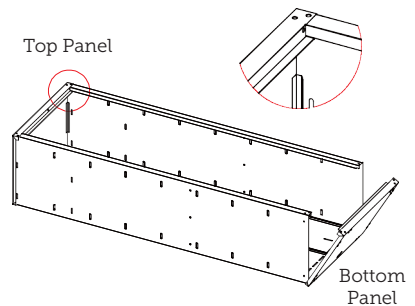

To install the top and bottom panels, the side panels should be inserted between the triangular lines on the inner side of the top and bottom panels and the sides. One end of the four round holes of the side plate is the upper end.

### STEP 5

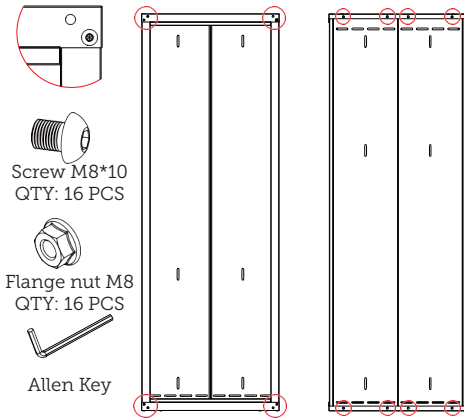

Bolt the top and bottom panels to the side back panels.

### STEP 6

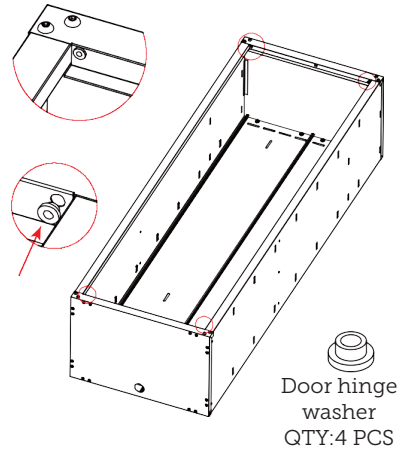

Install door hinge washer on the four corners of the top and bottom plates.

### STEP 7

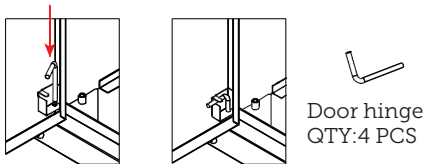

To install the left door, align the door hinge hole at the bottom of the left door with the center of the door hinge washer on the left side of the bottom plate, insert the door hinge, and then pin the door hinge to the door hinge washer. Install the door hinge and the right door in the same way.

### STEP 8

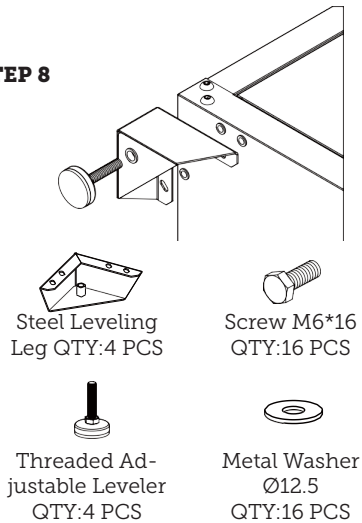

Screw the threaded adjustable leveler into the bottom of the steel leveling leg, and use 4 M6\*16 screws to fix the steel leveling leg to the bottom of the bottom panel, so that the outer side is aligned with the bottom panel. Install the other three feet the same way.

### STEP 9



Install door stopper

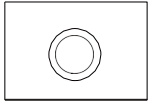

Install rubber ring

The rubber is installed at the rear of the bottom panel.

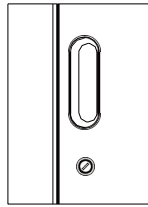

Install handle



Door stopper  
QTY:1 PCS



Handle  
QTY:1 PCS



Rubber ring  
QTY:1 PCS

### STEP 10

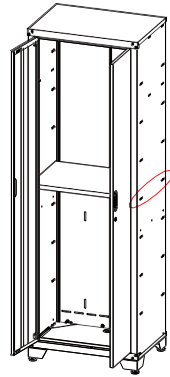

Upright the cabinet, install one of the shelves in the middle of the cabinet (for locking the door), and the other two shelves should be installed where convenient.

## Upper cabinets BOX 2 & 3

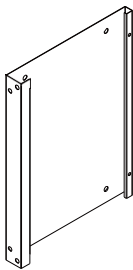

Side panel 2 PCS

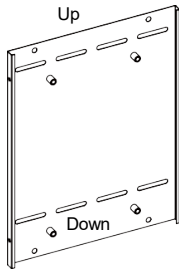

Back panel 2 PCS

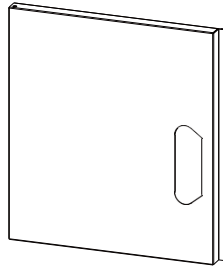

Left door 1 PCS

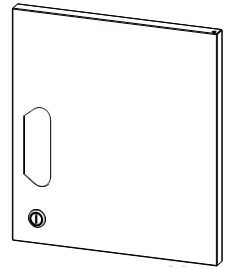

Right door 1 PCS

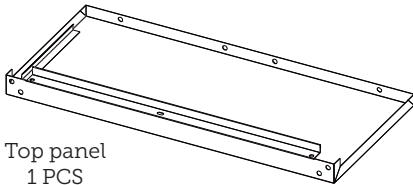

Top panel  
1 PCS

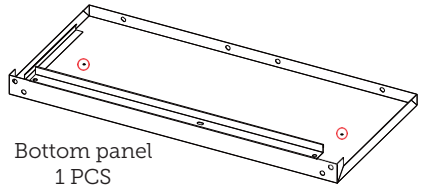

Bottom panel  
1 PCS



Install the upper cabinets just like the tall cabinet. The upper cabinet has no shelves and rubber rings, please ignore these two items.



# Cabinet BOX 4

GB

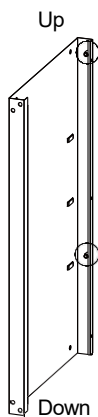

Left side panel  
1 PCS

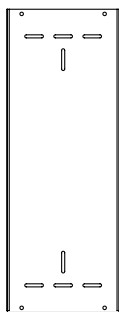

Back panel  
2 PCS

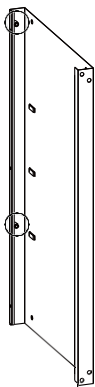

Right side panel  
1 PCS

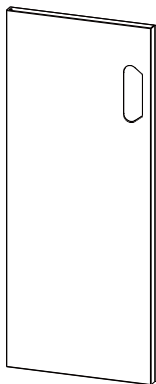

Left door  
1 PCS

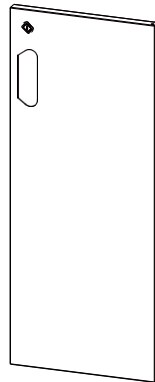

Right door  
1 PCS

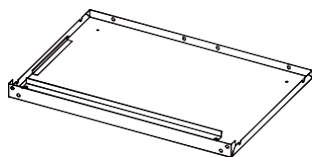

Top Panel  
1 PCS



Please install the base cabinet according to the tall cabinet assembly instructions.



In step2 and Step3 the side panel and back panel are connected with bolts and nuts.



Nut M5  
QTY:9 PCS



Screw M5\*10  
QTY:9 PCS

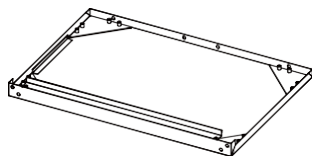

Bottom Panel  
1 PCS



Step10 the shelf can be adjusted at will.

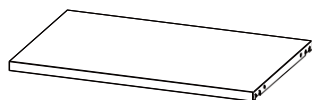

Shelf 1 PCS

# Connection Holes

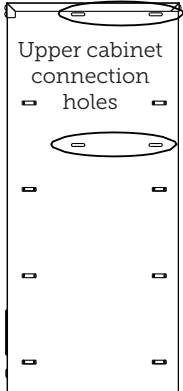

Upper cabinet connection holes

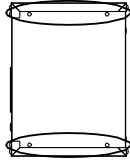

Side view of upper cabinet

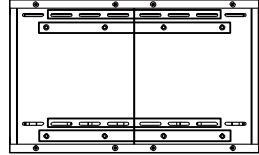

Back view of upper cabinet

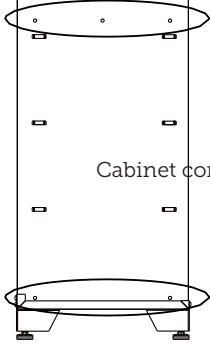

Right view of tall cabinet

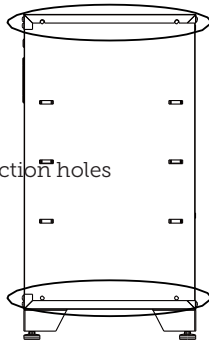

Side view of cabinet

Cabinet connection holes

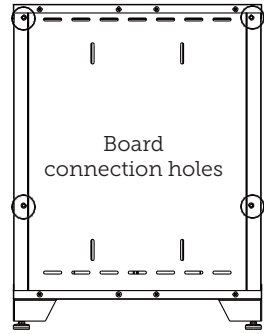

Back view of cabinet

Board connection holes

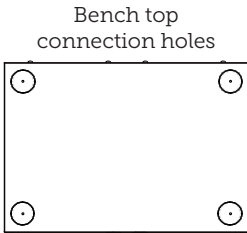

Top view of cabinet

Bench top connection holes

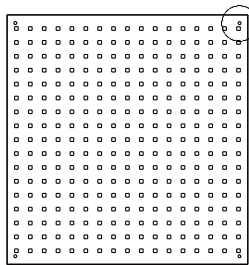

Tool Board

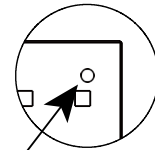

Wall cabinet connection hole

# Mount to the Wall

## STEP 1

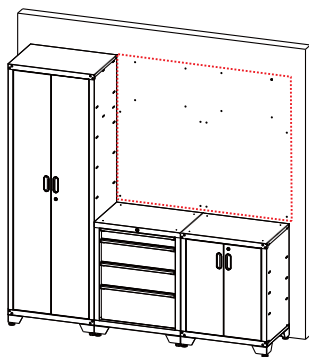

Wall Plug  
QTY:16 PCS

GB

Plan the placement of the tool cabinet, determine the position of the connecting hole between the tool board and the upper cabinet, then fix the wall plug. The feet of the high cabinet and the base cabinet can be raised, and the position of the wall plug can be a little higher.

## STEP 2

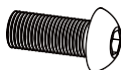

Screw M8\*18  
QTY:8 PCS



Flange nut M8  
QTY:4 PCS

Arrange the tall and the upper cabinets in their respective positions, align them, and connect them in pairs. Riveting nuts have been installed on the side panels of the drawer cabinet, there is no need to use the nuts when connecting other cabinets.

## STEP 3

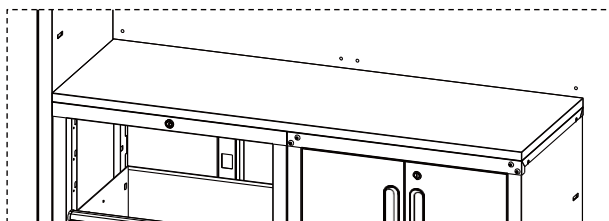

Self-tapping screw  
M5\*15  
QTY:8 PCS

Install the benchtop. Screw the self-tapping screws into the benchtop through the mounting holes on the top of the cabinet, making sure that the benchtop is aligned with the outside of the base cabinet.

Remove more drawers if necessary, and finally install the drawers back in place.

#### STEP 4

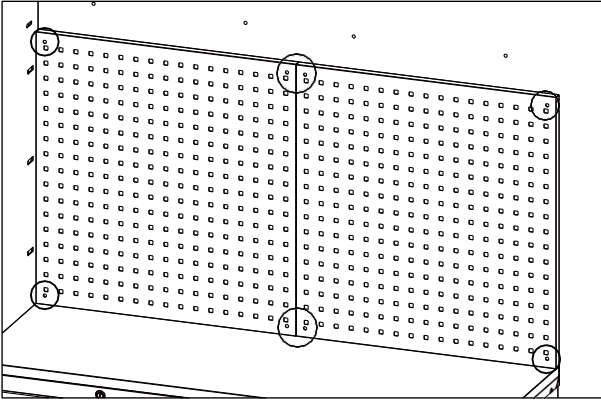

Wood screw M6\*60  
QTY:8 PCS



Metal washer Ø22.8  
QTY:8 PCS

Install the tool board. The large self-tapping screws must pass through the round holes at the four corners of the tool board and screw into the wall plug on the wall to fix the tool board to the wall.

#### STEP 5

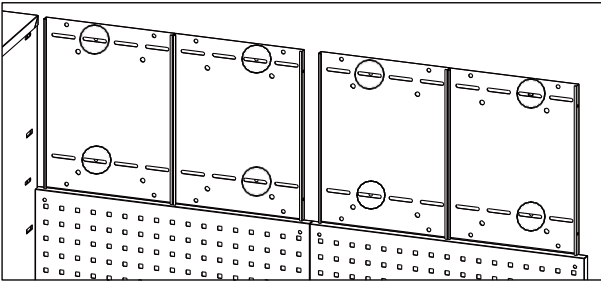

Wood screw M6\*60  
QTY:8 PCS



Metal washer Ø22.8  
QTY:8 PCS

To install the cabinet, screw in the large self-tapping screw through the hole on the back panel of the wall cabinet into the wall plug to fix the cabinet.

#### STEP 6

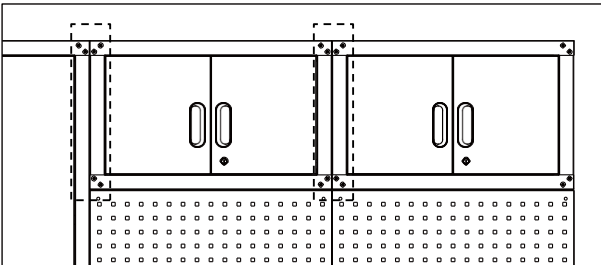

Screw M8\*18  
QTY:8 PCS



Flange nut M8  
QTY:8 PCS

Bolts and nuts are used between upper cabinets and the tall cabinet.

---

**SERVICE CENTRE**

Note: Please provide the product model number in connection with all inquiries.

The model number is shown on the front of this manual and on the product rating plate.

*For:*

- Complaints
  - Replacements parts
  - Returns
  - Guarantee issues
  - [www.schou.com](http://www.schou.com)
- 

Manufactured in China

Manufacturer:

Schou Company A/S  
Nordager 31  
DK-6000 Kolding

All rights reserved. The content of this manual may not be reproduced, either in full or in part, in any way by electronic or mechanical means, e.g. photocopying or publication, translated or saved in an information storage and retrieval system without written permission from Schou Company A/S.

---

# Garagenarbeitsplatz

## EINFÜHRUNG

Damit Sie an Ihrem neuen Produkt möglichst lange Freude haben, bitten wir Sie, die Gebrauchsanweisung und die beiliegenden Sicherheitshinweise vor Ingebrauchnahme sorgfältig durchzulesen.

Ferner wird empfohlen, die Gebrauchsanweisung für den Fall aufzubewahren, dass Sie sich die Funktionen des Produkts später nochmals ins Gedächtnis rufen möchten.

## TECHNISCHE DATEN

Schrank, zweitürig, mit drei Einlegeböden,  
66 x 45,7 x 198,1 cm. (B x T x H)

Zwei Oberschränke, zweitürig,  
66 x 30,5 x 40,6 cm. (B x T x H)

Zwei Werkzeugtafeln mit Bohrungen  
für Haken, 66 x 68,4 x 2 cm. (B x T x H)

Massivholz-Tischplatte,  
132 x 45,7 x 2,5 cm. (B x T x H)

Unterschrank mit vier Schubladen  
66 x 45,7 x 86,4 cm. (B x T x H)

Unterschrank, zweitürig, mit Einlegeboden,  
66 x 45,7 x 86,4 cm. (B x T x H)

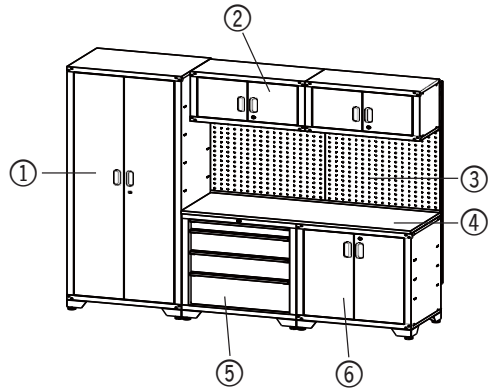

## BESONDERE SICHERHEITSHINWEISE

Der Garagenarbeitsplatz muss senkrecht stehen und an einer Wand befestigt sein. Er darf nicht frei stehen!

Es empfiehlt sich, die Schrankmöbel mindestens zu zweit zu bewegen, zusammenzubauen und zu installieren. Andernfalls kann es zu Verletzungen des Rückens und anderer Körperteile kommen.

## TEILE DES GARAGENARBEITSPLATZES

1. Schrank, zweitürig, mit drei Einlegeböden
2. Zwei Oberschränke
3. Zwei Werkzeugtafeln
4. Arbeitsplatte
5. Unterschrank mit vier Schubladen
6. Unterschrank, zweitürig, mit Einlegeboden

# Teile

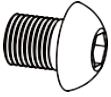

Schraube  
M8x10

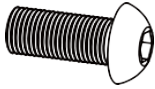

Schraube  
M8x18



Flanschmutter  
M8



Schraube  
M5x10



Mutter  
M5



Holzschraube  
M6x60

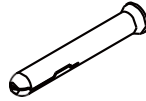

Wand-  
dübel



Metallunterleg-  
scheibe Ø22,8



Blechschaube M5x15

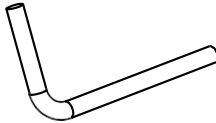

Türscharnier

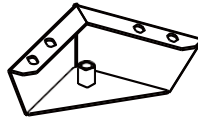

Einstellbarer  
Stahlfuß



Höhenein-  
stellung mit  
Gewinde

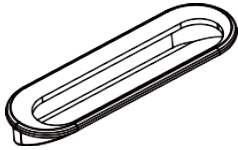

Griff



Gummiring



Sechskant-  
schlüssel

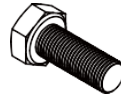

Schraube  
M6x16



Metallunter-  
legscheibe  
Ø12,5



Türscharnier-  
aufnahme

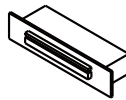

Türanschlag

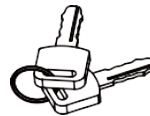

Schlüssel

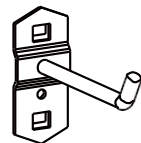

Haken

# Teilleiste

	Karton 1	Kar- ton 2	Kar- ton 3	Kar- ton 4	Kar- ton 5	Kar- ton 6
Bezeichnung / Anzahl						
Schraube M8x10	16	16	16	16	0	0
Schraube M8x18	0	4	4	4	4	0
Flanschmutter M8	16	20	20	20	0	0
Schraube M5x10	18	6	6	9	0	0
Mutter M5	6	2	2	9	0	0
Schraube M6x16	16	0	0	16	16	0
Metallunterleg- scheibe Ø12,5	16	0	0	16	16	0
Holzschraube M6x60	0	4	4	0	8	0
Wanddübel	0	4	4	0	8	0
Metallunterleg- scheibe Ø22,8	0	4	4	0	8	0
Blechschraube M5x15	0	0	0	4	4	0
Türscharnier	4	4	4	4	0	0
Türscharnierauf- nahme	4	4	4	4	0	0
Einstellbarer Stahlfuß	4	0	0	4	4	0
Höheneinstellung mit Gewinde	4	0	0	4	4	0
Griff	2	2	2	2	0	0
Türanschlag	4	4	4	4	0	0
Gummiring	1	0	0	0	0	0
Sechskantschlüs- sel	0	0	0	0	1	0
Schlüssel	2	2	2	2	2	0
Haken	0	0	0	0	10	0



# Zusammenbau

## Hoher Lagerschrank, Karton 1

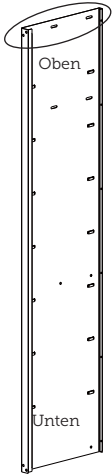

Linke Seitenwand, 1 Stück



Rückwand 2 Stück

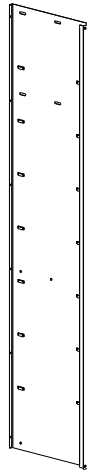

Rechte Seitenwand, 1 Stück

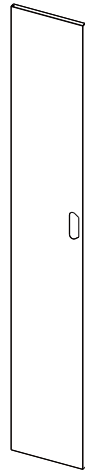

Linke Tür, 1 Stück

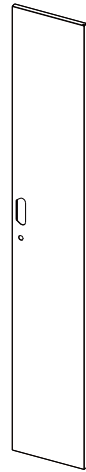

Rechte Tür, 1 Stück

DE

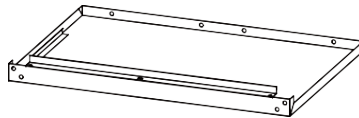

Deckplatte, 1 Stück

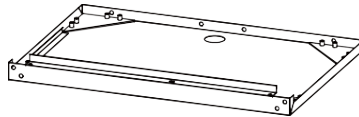

Bodenplatte, 1 Stück



Einlegeböden, 3 Stück

## SCHRITT 1

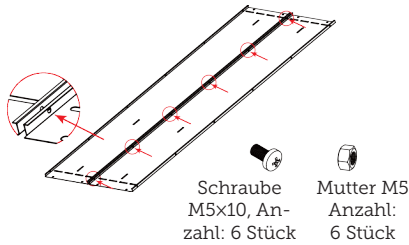

Legen Sie die beiden Rückwände flach nebeneinander und verbinden Sie beide mit M5x10-Schrauben und -Muttern. Achten Sie darauf, dass die Lage der oberen und unteren Endlöcher übereinstimmt.

## SCHRITT 2

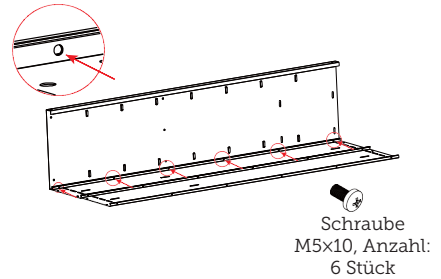

Platzieren Sie die linke Platte wie dargestellt und verbinden Sie diese mittels M5x10-Schrauben mit der Rückwand. Achten Sie auf die Lage der oberen und unteren Endlöcher.

## SCHRITT 3

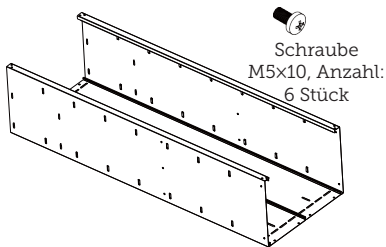

Montieren Sie die rechte Seitenwand wie in Schritt 2 beschrieben. Achten Sie auf die Lage der oberen und unteren Endlöcher – beide Seitenplatten sind symmetrisch.

## SCHRITT 4

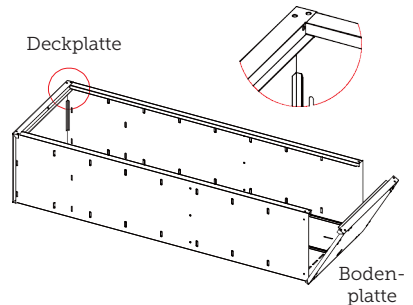

Zur Montage von Deck- und Bodenplatte müssen die Seitenwände zwischen den dreieckigen Linien an der Innenseite der Deck- und Bodenplatten und den Seiten eingefügt werden. Das Ende mit den vier runden Löchern in den Seitenplatten ist das obere Ende.

## SCHRITT 5

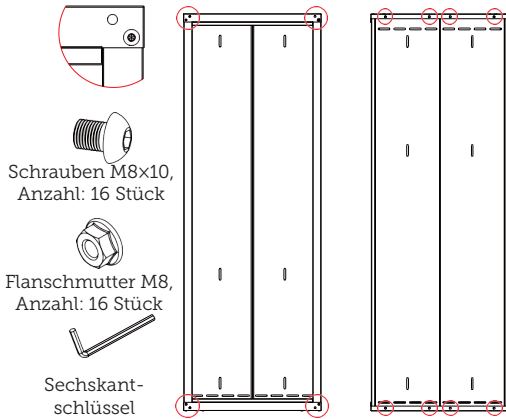

Verschrauben Sie die Deck- und Bodenplatte mit den Seiten- und Rückwänden.

## SCHRITT 7

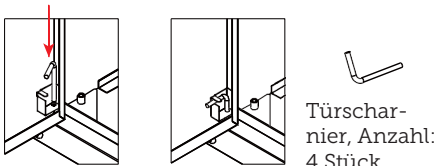

Um die linke Tür einzubauen, richten Sie das Türscharnierloch an der Unterseite der linken Tür auf die Mitte der Türscharnieraufnahme an der linken Seite der Bodenplatte aus, setzen Sie das Türscharnier ein und stecken Sie das Türscharnier in die Türscharnieraufnahme. Montieren Sie die rechte Tür und ihr Türscharnier auf die gleiche Weise.

## SCHRITT 6

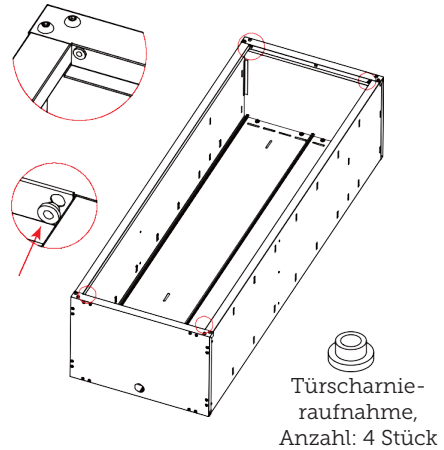

Montieren Sie die Türscharnieraufnahmen an den vier Ecken der Deck- und der Bodenplatte.

## SCHRITT 8

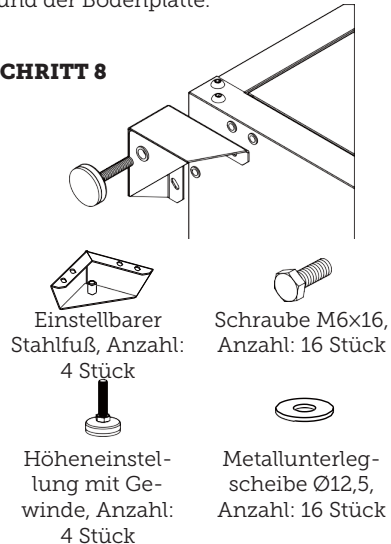

Schrauben Sie die Höheneinstellung mit Gewinde in die Unterseite des einstellbaren Stahlfußes, und befestigen Sie den einstellbaren Stahlfuß mit vier M6x16-Schrauben an der Unterseite der Bodenplatte, sodass die Außenseite mit der Bodenplatte abschließt. Montieren Sie die anderen drei Füße auf die gleiche Weise.

## SCHRITT 9

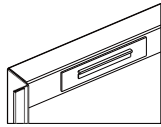

Türanschlag anbringen



Gumming anbringen

Bringen Sie das Gummi an der Rückseite der Bodenplatte an.

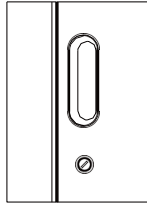

Griff anbringen



Türanschlag,  
Anzahl: 1 Stück



Griff,  
Anzahl: 1 Stück



Gumming, Anzahl: 1 Stück

## SCHRITT 10

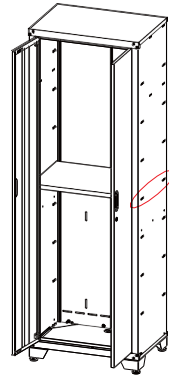

Stellen Sie den Schrank aufrecht und bringen Sie einen der Einlegeböden in der Mitte des Schrankes an (zum Verschießen der Tür). Die beiden anderen Einlegeböden können an einer geeigneten Stelle angebracht werden.

## Oberschränke, Kartons 2 und 3

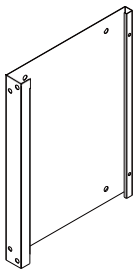

Seitenwände,  
2 Stück

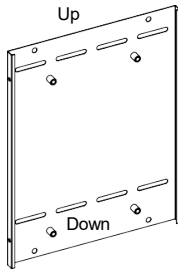

Rückwand  
2 Stück

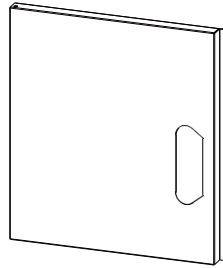

Linke Tür,  
1 Stück

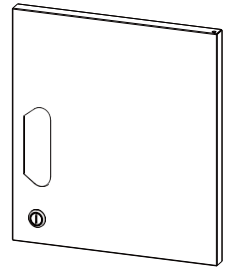

Rechte Tür,  
1 Stück

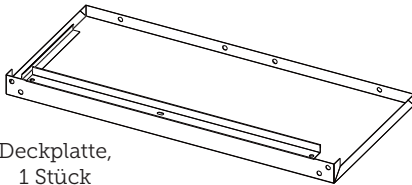

Deckplatte,  
1 Stück

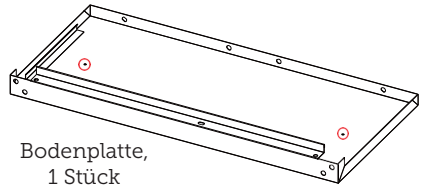

Bodenplatte,  
1 Stück



Bauen Sie die Oberschränke genauso zusammen wie den hohen Schrank. Die Oberschränke haben keine Einlegeböden und Gumminge – bitte übergehen Sie diese beiden Teile.

# Unterschrank, Karton 4

Up

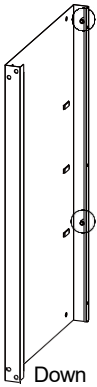

Down

Linke Seitenwand, 1 Stück



Rückwand  
2 Stück

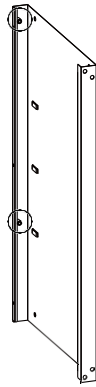

Rechte Seitenwand, 1 Stück

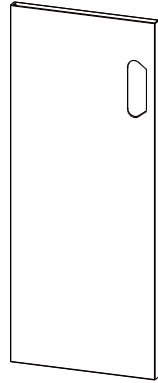

Linke Tür,  
1 Stück

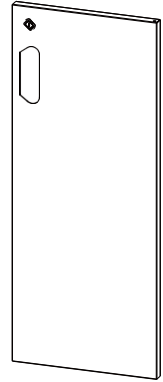

Rechte Tür,  
1 Stück

DE

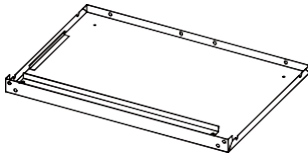

Deckplatte,  
1 Stück



Bitte montieren Sie den Unterschrank gemäß der Montageanleitung für den hohen Schrank.



In Schritt 2 und Schritt 3 werden die Seitenwand und die Rückwand mit Schrauben und Muttern verbunden.



Mutter M5  
Anzahl:  
9 Stück



Schraube  
M5x10, Anzahl:  
9 Stück

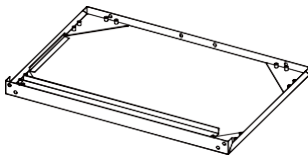

Bodenplatte,  
1 Stück



Schritt 10: Der Einlegeboden kann nach Belieben angebracht werden.

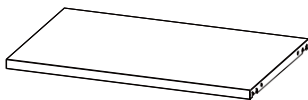

Einlegeböden,  
1 Stück

# Verbindungs­löcher

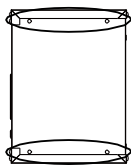
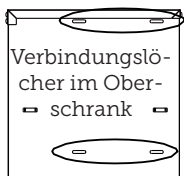

Seitenansicht des Oberschranks

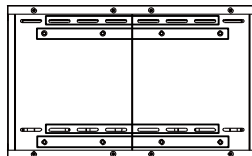

Rückansicht des Oberschranks

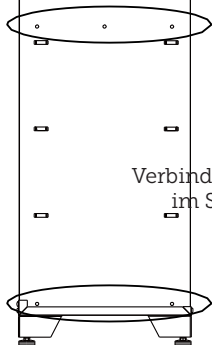

Ansicht des hohen Schranks von rechts

Verbindungs­löcher im Schrank

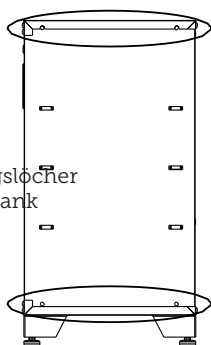

Seitenansicht des Schranks



Rückansicht des Schranks

Verbindungs­löcher der Arbeitsplatte

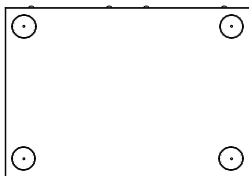

Draufsicht auf den Schrank

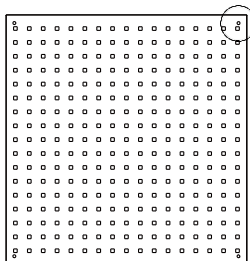

Werkzeugtafel

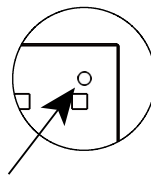

Wandver­bindungs­loch im Oberschrank

# Befestigung an der Wand

## SCHRITT 1

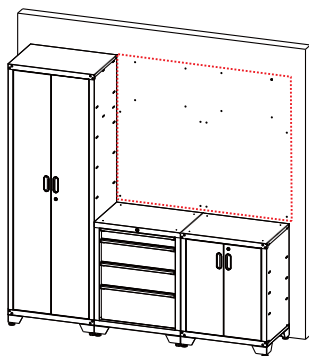

Wanddübel,  
Menge: 16 Stück

DE

Planen Sie die Platzierung des Werkzeugschranks, bestimmen Sie die Lage des Verbindungslochs zwischen der Werkzeuggestalt und dem Oberschrank und befestigen Sie dann den Wanddübel.

Die Füße des hohen Schrankes und der Unterschränke können höher gestellt werden. Deswegen kann die Lage des Dübels etwas höher sein.

## SCHRITT 2

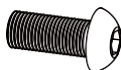

Schraube M8x18  
Anzahl: 8 Stück



Flanschnutter M8  
Anzahl: 4 Stück

Bringen Sie den hohen Schrank und die Oberschränke in ihre jeweilige Lage, richten Sie die Schränke aus und verbinden Sie sie paarweise aneinander. An den Seitenwänden des Schubladenschranks sind Einnietmuttern angebracht. Sie brauchen die Muttern bei der Verbindung mit den anderen Schränken nicht zu verwenden.

## SCHRITT 3

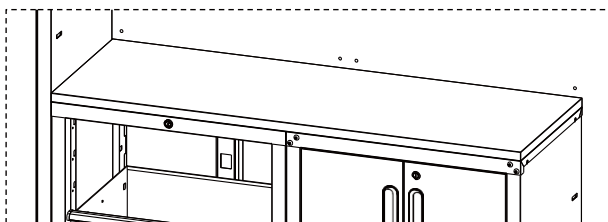

Blechschraube  
M5x15  
Anzahl: 8 Stück

Montieren Sie die Arbeitsplatte. Schrauben Sie die Blechschrauben durch die Befestigungslöcher an der Oberseite des Schrankes in die Arbeitsplatte und achten Sie darauf, dass die Arbeitsplatte mit der Außenseite des Unterschranks abschließt. Nehmen Sie nötigenfalls Schubladen heraus, und schieben Sie die Schubladen schließlich wieder zurück.

#### SCHRITT 4

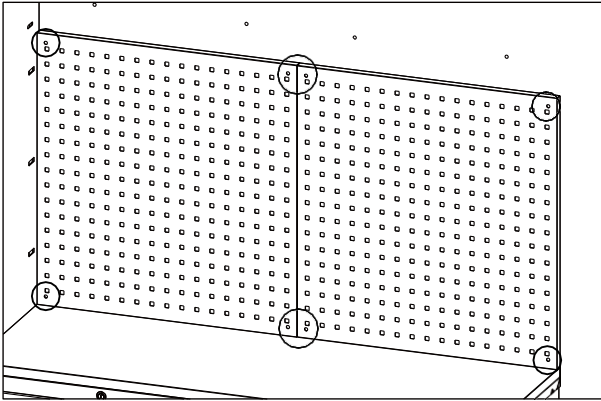

Holzschraube M6x60  
Anzahl: 8 Stück



Metallunterlegscheibe  
Ø22,8  
Anzahl: 8 Stück

Montieren Sie die Werkzeugtafel. Die großen Blechschrauben müssen durch die runden Löcher an den vier Ecken der Werkzeugtafel geführt und in den Dübel an der Wand geschraubt werden, um die Werkzeugtafel an der Wand zu befestigen.

#### SCHRITT 5

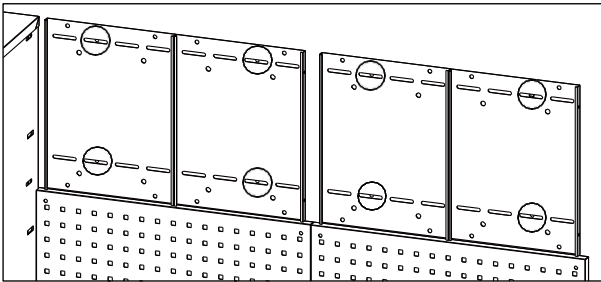

Holzschraube M6x60  
Anzahl: 8 Stück



Metallunterlegscheibe  
Ø22,8  
Anzahl: 8 Stück

Zur Befestigung des Schrankes schrauben Sie die große Blechschraube durch das Loch an der Rückwand des Oberschranks in den Dübel.

#### SCHRITT 6

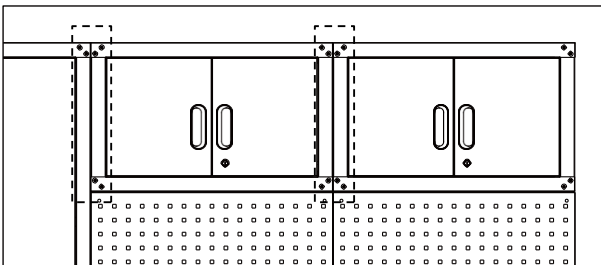

Schraube M8x18  
Anzahl: 8 Stück



Flanschmutter M8  
Anzahl: 8 Stück

Verwenden Sie Schrauben und Muttern zwischen den Oberschränken und dem hohen Schrank.



---

**KUNDENDIENSTZENTRUM**

Hinweis: Bitte geben Sie bei allen Anfragen die Modellnummer des Produkts an.

Die Modellnummer ist auf der Vorderseite dieser Gebrauchsanleitung und auf dem Typenschild des Produkts angegeben.

*Für:*

- Beanstandungen
- Ersatzteile
- Rücksendungen
- Garantieleistungen
- [www.schou.com](http://www.schou.com)

---

Hergestellt in China

Hersteller:

Schou Company A/S  
Nordager 31  
6000 Kolding  
Dänemark

Alle Rechte vorbehalten. Der Inhalt dieser Gebrauchsanleitung darf ohne schriftliche Genehmigung der Schou Company A/S weder ganz noch auszugsweise und auf keinerlei Weise elektronisch oder mechanisch vervielfältigt (etwa durch Fotokopie oder Veröffentlichung), übersetzt oder in einem Informationsspeicher- und -abrufsystem abgelegt werden.

---

# Zestaw mebli warsztatowych

## WPROWADZENIE

Aby w jak największym stopniu wykorzystać zalety nowego produktu, przed rozpoczęciem korzystania należy przeczytać niniejszą instrukcję obsługi. Należy zachować ten podręcznik na wypadek konieczności odniesienia się do niego w przyszłości.

## DANE TECHNICZNE

Szafa z 2. drzwiczkami i 3. półkami.  
66 x 45,7 x 198,1 cm. (SZxGxW)

2. szafki górne z 2. drzwiami każda. 66 x  
66 x 30,5 x 40,6 cm. (SZxGxW)

2. tablice narzędziowe z otworami na  
haczyki 66 x 68,4 x 2 cm. (SZxGxW)

Błat wykonany z litego drewna  
132 x 45,7 x 2,5 cm. (SZxGxW)

Moduł z 4. szufladami  
66 x 45,7 x 86,4 cm. (SZxGxW)

Szafka z 2. drzwiczkami i półką.  
66 x 45,7 x 86,4 cm. (SZxGxW)

## SPECJALNE WSKAZÓWKI DOTYCZĄCE BEZPIECZEŃSTWA

Mebel warsztatowy musi stać pionowo oraz być przymocowany do ściany. Nie mogą stać w stanie swobodnym!

Zaleca się, aby dwie osoby przenosiły, składały i montowały szafę. Niezastosowanie się do tego zalecenia może spowodować urazy np. pleców.

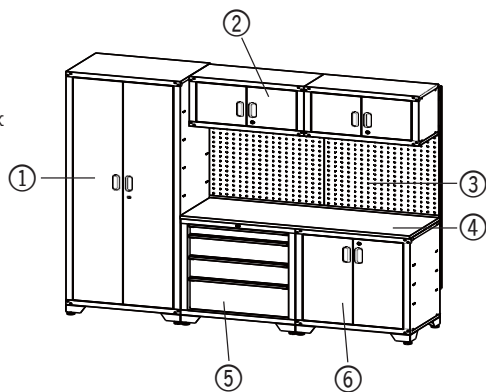

## CZĘŚCI SKŁADOWE ZESTAWU

1. Szafa z 2. drzwiami i 3. półkami
2. szafka górna
3. 2. tablice narzędziowe
4. Blat
5. Moduł z 4. szufladami
6. Szafka z 2. drzwiami oraz półką

# Części

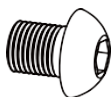

Śruba M8\*10

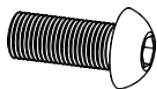

Śruba M8\*18



Nakrętka kołnierzowa M8



Śruba M5\*10



Nakrętka M5



Śruba do drewna M6\*60

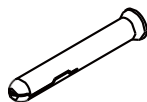

Kotek rozporowy do ściany



Podkładka metalowa Ø22,8



Śruba samogwintująca M5\*15

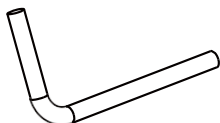

Zawias drzwiowy

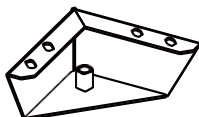

Stalowa noga poziomująca

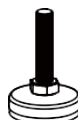

Gwintowana stopka

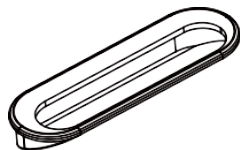

Uchwyt



Pierścień gumowy



Klucz imbusowy

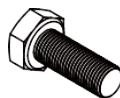

Śruba M6\*16



Podkładka metalowa Ø12,5



Podkładka pod zawias drzwiowy

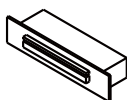

Blokada drzwi



Klucze

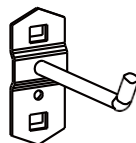

Hak

## Lista części

	Pudętko 1	Pudętko 2	Pudętko 3	Pudętko 4	Pudętko 5	Pudętko 6
Nazwa / Ilość						
Śruba M8*10	16	16	16	16	0	0
Śruba M8*18	0	4	4	4	4	0
Nakrętka kołnierzkowa M8	16	20	20	20	0	0
Śruba M5*10	18	6	6	9	0	0
Nakrętka M5	6	2	2	9	0	0
Śruba M6*16	16	0	0	16	16	0
Podkładka metalowa Ø12,5	16	0	0	16	16	0
Śruba do drewna M6*60	0	4	4	0	8	0
Kotek rozporowy do ściany	0	4	4	0	8	0
Podkładka metalowa Ø22,8	0	4	4	0	8	0
Śruba samogwintująca M5*15	0	0	0	4	4	0
Zawias drzwiowy	4	4	4	4	0	0
Podkładka pod zawias drzwiowy	4	4	4	4	0	0
Stalowa noga poziomująca	4	0	0	4	4	0
Gwintowana stopka	4	0	0	4	4	0
Uchwyt	2	2	2	2	0	0
Blokada drzwi	4	4	4	4	0	0
Pierścień gumowy	1	0	0	0	0	0
Klucz imbusowy	0	0	0	0	1	0
Klucze	2	2	2	2	2	0
Hak	0	0	0	0	10	0

# Montaż

## Szafa wysoka PUDEŁKO 1

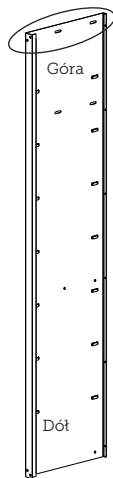

Lewy panel boczny 1 szt.



Panel tylny 2 szt.

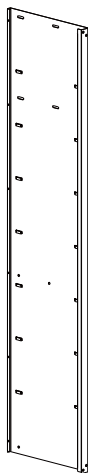

Prawy panel boczny 1 szt.

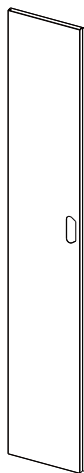

Drzwi lewe 1 szt.

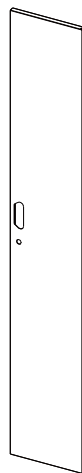

Drzwi prawe 1 szt.

PL

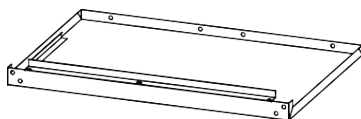

Panel górny 1 szt.

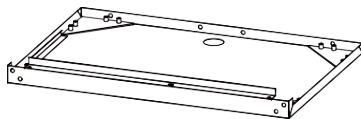

Panel dolny 1 szt.

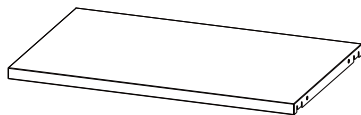

Półka 3 szt.

### KROK 1

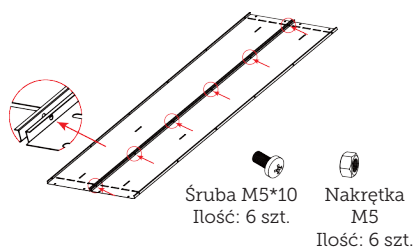

Ułożyć płasko dwa panele tylne i połączyć je za pomocą śrub M5\*10 oraz nakrętek. Zwrócić uwagę, aby górne i dolne otwory końcowe znajdowały się w tej samej pozycji.

### KROK 2

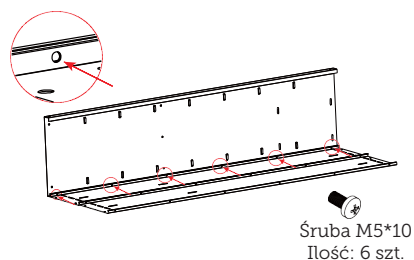

Umieścić lewy panel jak na rysunku i połączyć go z tylnym panelem za pomocą śrub M5\*10. Zwrócić uwagę na położenie górnych i dolnych otworów końcowych.

### KROK 3

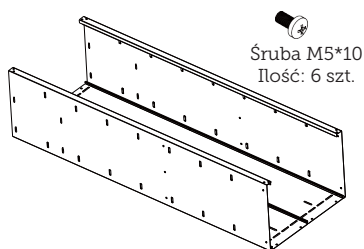

Zainstalować prawy panel boczny zgodnie z drugim krokiem. Zwrócić uwagę na położenie górnych i dolnych otworów końcowych, dwie płyty boczne są symetryczne.

### KROK 4

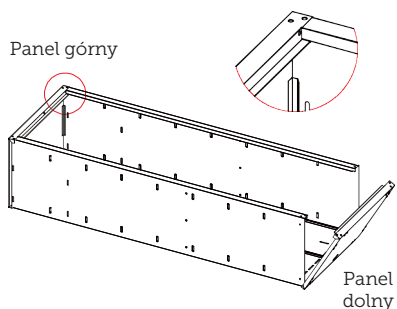

Aby zamontować panele górne i dolne, należy włożyć panele boczne pomiędzy trójkątne linie na wewnętrznej stronie paneli górnych i dolnych oraz na bokach. Jeden koniec z czterech okrągłych otworów płyty bocznej jest górnym końcem.

## KROK 5

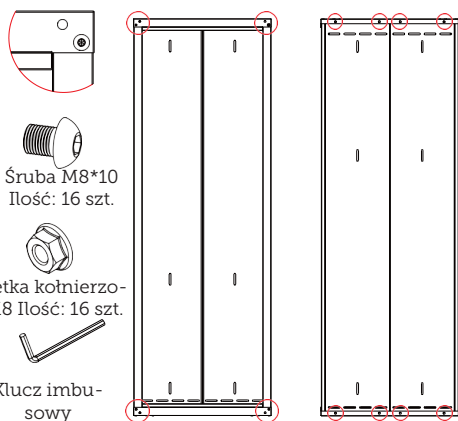

Przykręcić panel górny i dolny do boków paneli tylnych.

## KROK 7

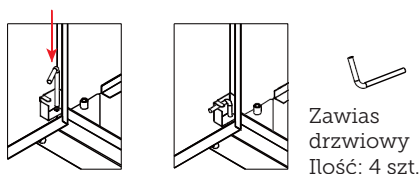

Aby zainstalować lewe drzwi, wyrównać otwór zawiasu na dole lewych drzwi ze środkiem podkładki zawiasu po lewej stronie panelu dolnego, włożyć zawias drzwiowy, a następnie przypiąć go. W ten sam sposób zamontować zawias drzwiowy oraz prawe drzwi.

## KROK 6

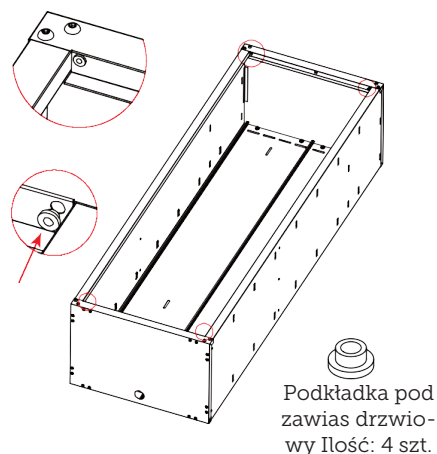

Zainstalować podkładkę pod zawias drzwiowy na czterech rogach płyty górnej i dolnej.

## KROK 8

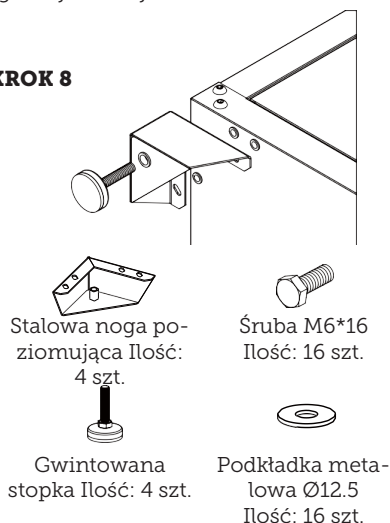

Przykręcić gwintowaną stopkę do dolnej części stalowej nogi poziomującej, następnie za pomocą 4 śrub M6\*16 przymocować stalową nogę poziomującą do dolnej części panelu, tak aby zewnętrzna strona była wyrównana z panelem dolnym. W ten sam sposób zainstalować pozostałe trzy nogi.

## KROK 9

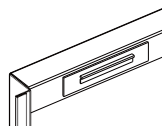

Zamontować blokadę drzwi

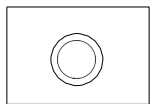

Zamontować pierścień gumowy  
Gumę montuje się w tylnej części dolnego panelu.



Blokada drzwi  
Ilość: 1 szt.



Uchwyt  
Ilość: 1 szt.



Pierścień gumowy  
Ilość: 1 szt.

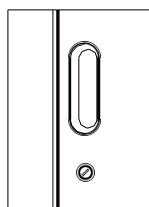

Zamontować uchwyt

## KROK 10

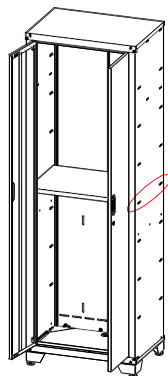

Postawić szafę, jedną z półek zamontować na środku (do blokowania drzwi), a pozostałe dwie półki zamontować tam, gdzie jest to wygodne.

## Szafka górna PUDEŁKO 2 i 3

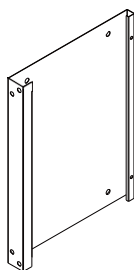

Panel boczny  
2 szt.

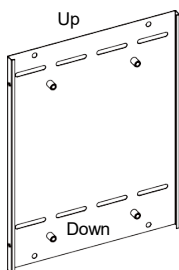

Panel tylny 2 szt.

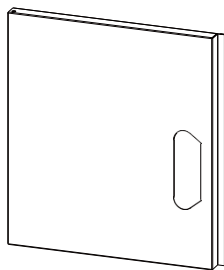

Drzwi lewe  
1 szt.

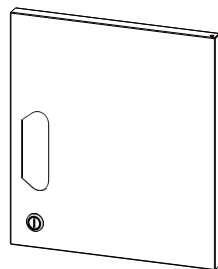

Drzwi prawe  
1 szt.

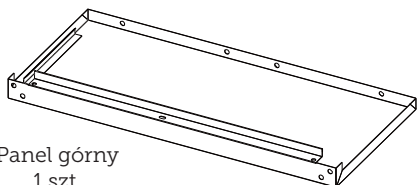

Panel górny  
1 szt.

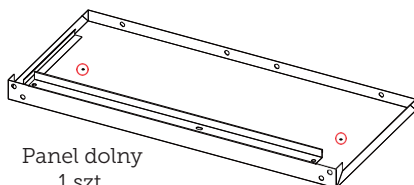

Panel dolny  
1 szt.



Zmontować szafka górne tak samo jak szafę wysoką. Górna szafka nie posiada półek i gumowych pierścieni, proszę pominąć te dwa elementy.



# Szafka PUDEŁKO 4

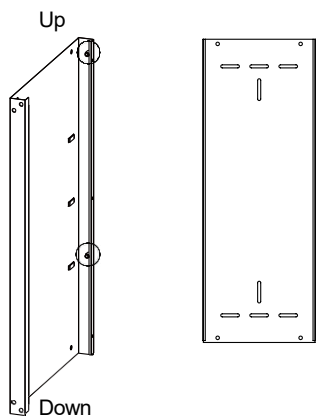

Lewy panel boczny 1 szt.

Panel tylny 2 szt.

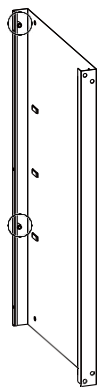

Prawy panel boczny 1 szt.

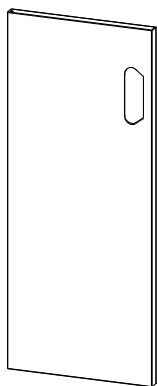

Drzwi lewe 1 szt.

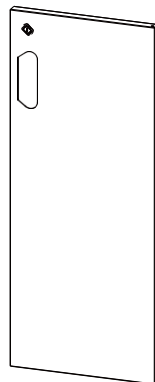

Drzwi prawe 1 szt.

PL

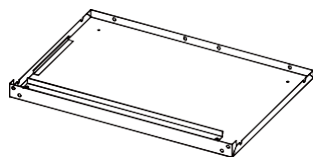

Panel górny 1 szt.



Proszę zamontować szafkę dolną zgodnie z instrukcją montażu szafy wysokiej.



W kroku 2 i 3 panel boczny i panel tylny są połączone śrubami i nakrętkami.



Nakrętka M5  
Ilość: 9 szt.



Śruba M5\*10  
Ilość: 9 szt.

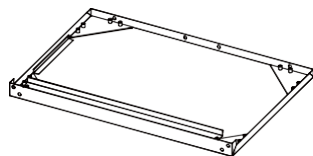

Panel dolny 1 szt.



Krok 10 półka może być dowolnie regulowana.

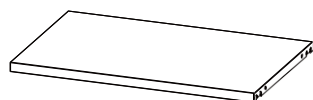

Półka 1 szt.

# Otwory montażowe

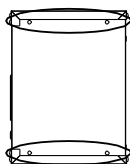
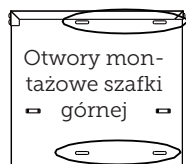

Widok z boku szafki górnej

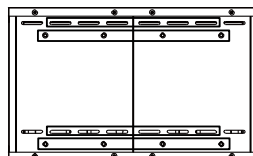

Widok z tyłu szafki górnej

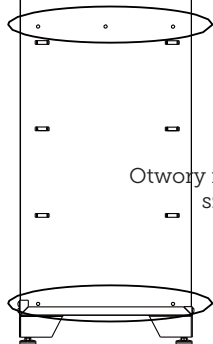

Widok z prawej strony szafy wysokiej

Otwory mocowania szafki

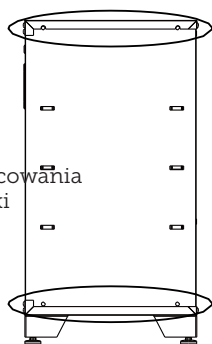

Widok szafki z boku

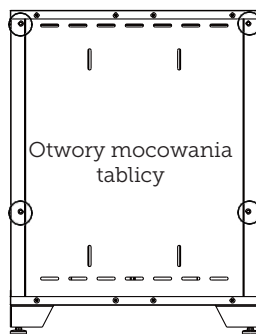

Widok szafki z tyłu

Górne otwory montażowe blatu

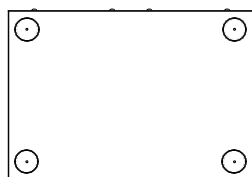

Widok szafy z góry

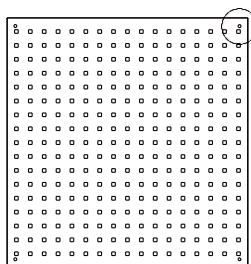

Tablica narzędziowa

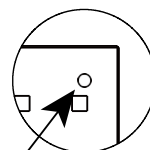

Otwór mocowania szafki wiszącej

# Montaż do ściany

## KROK 1

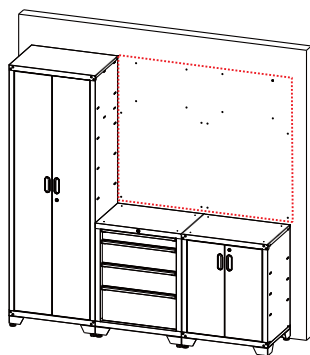

Kotek rozporowy  
do ściany,  
Ilość: 16 szt.

PL

Zaplanuj umieszczenie szafki narzędziowej, ustal położenie otworu łączącego tablicę narzędziową z szafką górną, następnie zamocuj kotek rozporowy. Nóżki szafki wysokiej i szafki dolnej mogą być podniesione, a położenie kotka rozporowego może być nieco wyższe.

## KROK 2

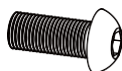

Śruba M8\*18  
Ilość: 8 szt.



Nakrętka kołnierzowa M8  
Ilość: 4 szt.

Umieść szafę wysoką oraz górną w odpowiednich miejscach, wyrównaj oraz połącz parami. Nitonakrętki zostały zainstalowane na bocznych panelach szafki szufladowej, nie ma potrzeby stosowania nakrętek przy łączeniu szafek.

## KROK 3

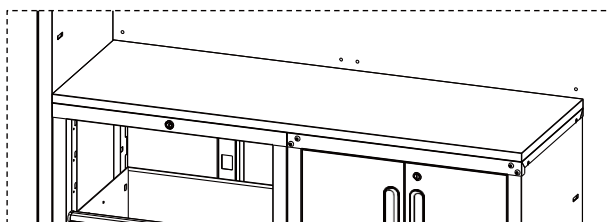

Śruba samogwin-  
tująca  
M5\*15  
Ilość: 8 szt.

Zamontować blat stołu. Wkręcić śruby samogwintujące w blat przez otwory montażowe w górnej części, upewniając się, że blat jest wyrównany z zewnętrzną częścią szafek.

W razie potrzeby wyjąć kolejne szuflady, a na koniec zamontować je z powrotem na miejscu.

## KROK 4

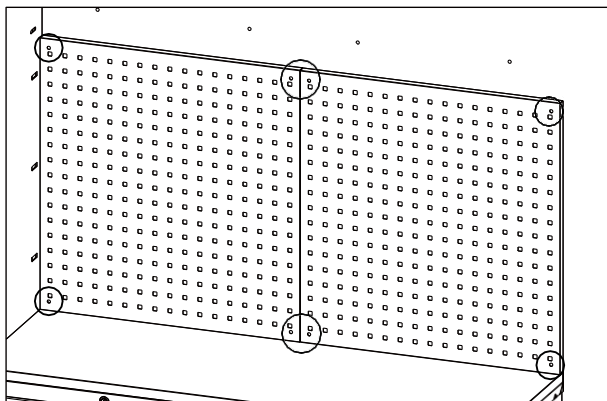

Zamontować tablicę narzędziową. Duże śruby samogwintujące muszą przejść przez okrągłe otwory znajdujące w czterech rogach tablicy narzędziowej oraz wkręcić się w kątki rozporowe w ścianie.



Śruba do drewna  
M6\*60 Ilość: 8 szt.



Podkładka metalowa Ø22,8  
Ilość: 8 szt.

## KROK 5

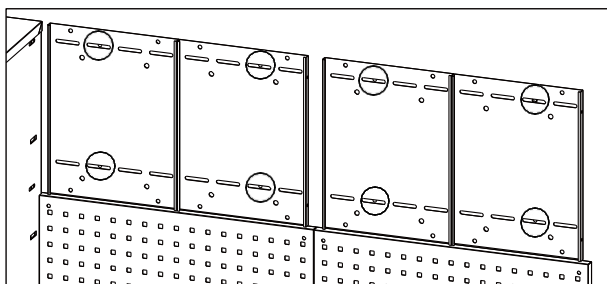

Aby zamontować szafkę, wkręć duże wkręty samogwintujące przez otwór znajdujące w tylnej ścianie szafki do kołków rozporowych.



Śruba do drewna  
M6\*60 Ilość: 8 szt.



Podkładka metalowa Ø22,8  
Ilość: 8 szt.

## KROK 6

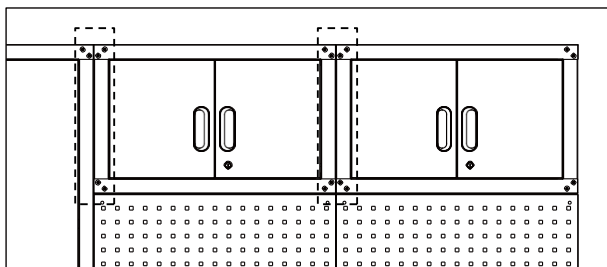

Szafkę wysoką oraz szafki górne należy skręcić przy pomocy śrub i nakrętek.



Śruba M8\*18  
Ilość: 8 szt.



Nakrętka kołnierзова  
M8

Ilość: 8 szt.

---

**CENTRUM SERWISOWE**

Uwaga: W przypadku wszelkich zapytań prosimy o podanie numeru modelu.

Numer modelu znajduje się na przedniej stronie niniejszej instrukcji obsługi oraz na etykiecie znamionowej produktu.

*W celu:*

- Reklamacji
  - Części zamiennych
  - Zwrotów
  - Naprawy gwarancyjnej
  - [www.schou.com](http://www.schou.com)
- 

Wyprodukowano w Chinach

Producent:

Schou Company A/S  
Nordager 31  
DK-6000 Kolding

---

Wszelkie prawa zastrzeżone. Treść niniejszej instrukcji nie może być bez pisemnej zgody Schou Company A/S: powielana w całości lub części, w jakikolwiek sposób za pomocą środków elektronicznych lub mechanicznych, np. fotokopii lub publikacji oraz tłumaczona lub zapisywana w systemach przechowywania i wyszukiwania informacji.

# Garaaži hoiusüsteem

## SISSEJUHATUS

Uue toote parimaks kasutamiseks tutvuge palun eelnevalt käesoleva juhendiga. Hoidke kasutusjuhend hilisemaks kasutamiseks alles.

## TEHNILISED ANDMED

Kapp koos 2 ukse ja 3 riiuliga.  
66 x 45,7 x 198,1 cm. (LxSxK)

2 ülemist kappi, kumbki 2 uksega,  
66 x 30,5 x 40,6 cm. (LxSxK)

2 tööriistalauda konksude jaoks  
mõeldud aukudega  
66 x 68,4 x 2 cm. (LxSxK)

Massiivpuidust töölaud  
132 x 45,7 x 2,5 cm. (LxSxK)

Moodul 4 sahtliga  
66 x 45,7 x 86,4 cm. (LxSxK)

Kapp 2 ukse ja riiuliga.  
66 x 45,7 x 86,4 cm. (LxSxK)

## OHUTUSALASED ERIJUHISED

Garaaži hoiusüsteem peab seisma püsti ja olema kinnitatud tagaseina külge. Seda ei tohi jätta kinnitamata seisma!

Kappi on soovituslik liigutada, kokku panna ja paigaldada kahel inimesel. Vastasel juhul võib see põhjustada selja- või muid vigastusi.

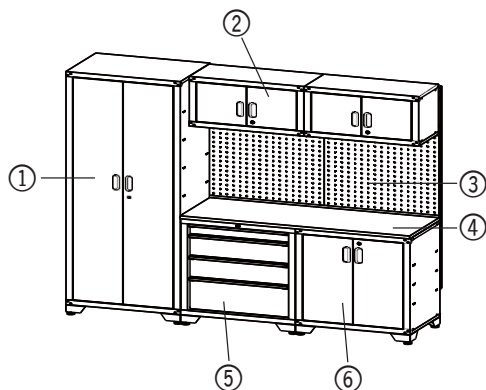

## GARAAŽI HOIUSÜSTEEMI OSAD

1. Kapp koos 2 ukse ja 3 riiuliga
2. 2 ülemist kappi
3. 2 tööriistalauda
4. Töölaud
5. Moodul koos 4 sahtliga
6. Kapp koos 2 ukse ja riiuliga

# Osad

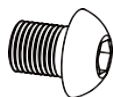

Kruvi M8\*10

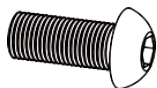

Kruvi M8\*18



Äärikmutter  
M8



Kruvi M5\*10



Mutter  
M5



Puidukruvi M6\*60

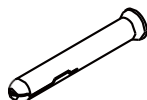

Seinapistik



Metallseib Ø22,8



Isekeermestav kruvi  
M5\*15

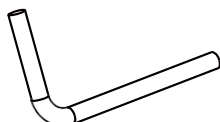

Uksehing

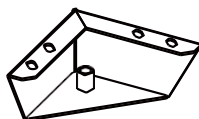

Terasest  
tasandusjalg

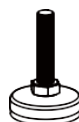

Keermestatud  
reguleeritav nivel-  
leerija

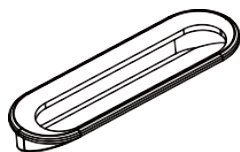

Sang



Kummirõngas



Sisekuuskantvõti

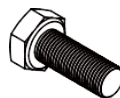

Kruvi M6\*16



Metallseib  
Ø12,5



Uksehinge  
seib

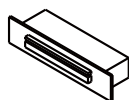

Uksestopper



Võti

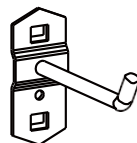

Konks

ET

## Osade nimekiri

	Box1	Box2	Box3	Box4	Box5	Box6
Nimi / kogus						
Kruvi M8*10	16	16	16	16	0	0
Kruvi M8*18	0	4	4	4	4	0
Äärikmutter M8	16	20	20	20	0	0
Kruvi M5*10	18	6	6	9	0	0
Mutter M5	6	2	2	9	0	0
Kruvi M6*16	16	0	0	16	16	0
Metallseib Ø12,5	16	0	0	16	16	0
Puidukruvi M6*60	0	4	4	0	8	0
Seinapistik	0	4	4	0	8	0
Metallseib Ø22,8	0	4	4	0	8	0
Isekeermestav kruvi M5*15	0	0	0	4	4	0
Uksehing	4	4	4	4	0	0
Uksehinge seib	4	4	4	4	0	0
Terasest tasan-dusjalg	4	0	0	4	4	0
Keermestatud reguleeritav nivelleerija	4	0	0	4	4	0
Sang	2	2	2	2	0	0
Uksestopper	4	4	4	4	0	0
Kummirõngas	1	0	0	0	0	0
Sisekuuskantvõti	0	0	0	0	1	0
Võti	2	2	2	2	2	0
Konks	0	0	0	0	10	0



# Kokkupanek

## Kõrge hoiukapp BOX1

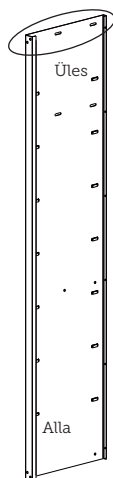

Vasakpoolne külgpaneel  
1 TK



Tagapaneel  
2 TK

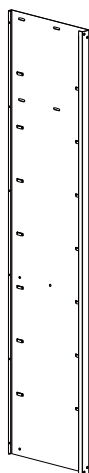

Parempoolne külgpaneel  
1 TK

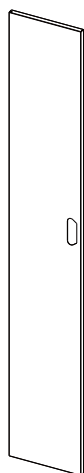

Vasakpoolne uks  
1 TK

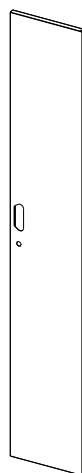

Parempoolne uks  
1 TK

ET

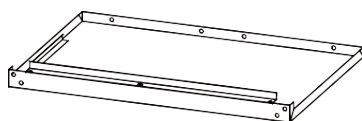

Ütemine paneel 1 TK

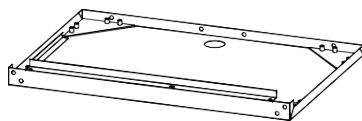

Alumine paneel 1 TK

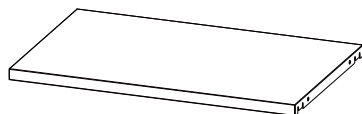

Riiul 3 TK

### 1. SAMM

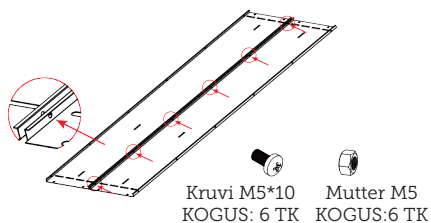

Asetage kaks tagapaneeli tasasel ja ühendage need omavahel M5\*10 kruvide ja mutritega. Pange tähele, et ülemine ja alumine otsaauk on samas asendis.

### 2. SAMM

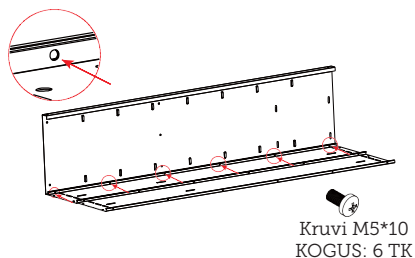

Asetage vasakpoolne paneel, nagu pildil näidatud, ja ühendage see tagapaneeliga, kasutades M5\*10 kruvisid. Pöörake tähelepanu ülemise ja alumise otsa augu asukohta.

### 3. SAMM

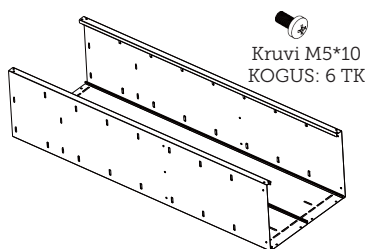

Paigaldage parempoolne külgs paneel vastavalt teisele sammule. Pöörake tähelepanu ülemise ja alumise otsaaukude asukohale, kaks külgsplaati on sümmeetrilised.

### 4. SAMM

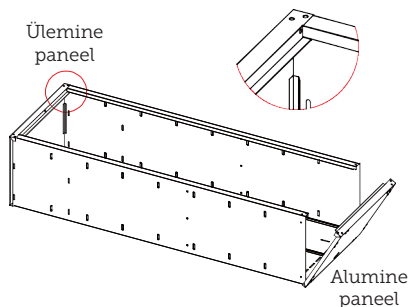

Ülemiste ja alumiste paneelide paigaldamiseks tuleb külgspaneelid asetada ülemiste ja alumiste paneelide siseküljel olevate kolmnurksete joonte ja külgede vahele. Külgsplaadi nelja ümmarguse augu üks ots on ülemine ots.

## 5. SAMM

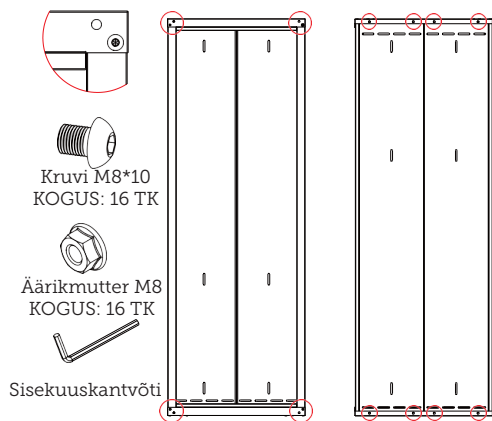

Kinnitage ülemine ja alumine paneel külgmiste tagapaneelide külge.

## 6. SAMM

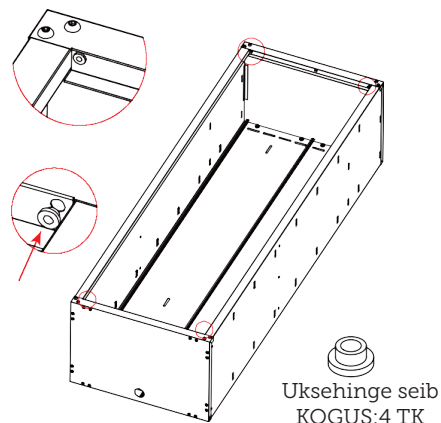

Paigaldage uksehinge seib ülemise ja alumise plaadi nelja nurka.

## 7. SAMM

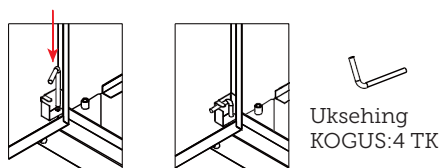

Vasakupoolse ukse paigaldamiseks joon-  
dage vasaku ukse allosas olev uksehing  
ava alumise plaadi vasakpoolses osas  
oleva uksehinge seibi keskpunktiga,  
sisestage uksehing ja seejärel kinnitage  
uksehing uksehinge seibiga. Paigaldage  
uksehing ja parempoolne uks samamoo-  
di.

## 8. SAMM

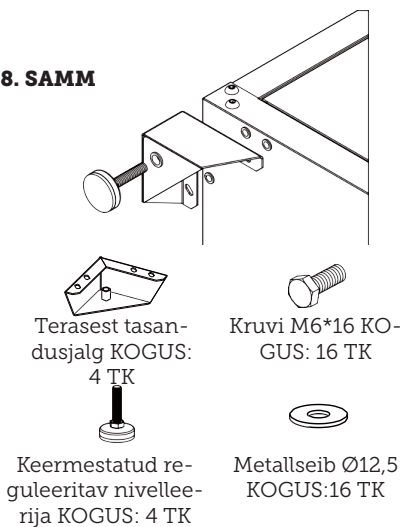

Kruvige keermestatud reguleeritav nivelleerija  
terasest terasjala põhja ja kinnitage teras-  
jalg 4 M6\*16 kruviga alumise paneeli põhja  
külge, nii et väliskülg oleks alumise paneeliga  
joondatud.  
Paigaldage ülejäänud kolm jalga samamoodi.

## 9. SAMM

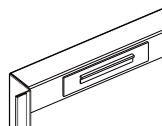

Paigaldage uksestopper

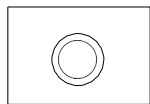

Paigaldage kummirõngas

Kumm on paigaldatud alumise paneeli tagaküljele.



Uksestopperisang KOGUS: 1 TK Kummirõngas KOGUS: 1 PCS

KOGUS: 1 TK

## 10. SAMM

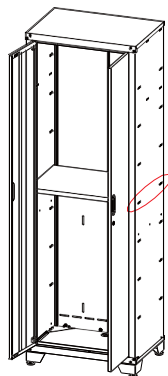

Tõstke kapi püsti, paigaldage üks riiuliplaatidest kapi keskele (ukse lukustamiseks) ja ülejäänud kaks riiulit paigaldage sinna, kus on mugav.

## Ülemised kapid BOX2 & 3

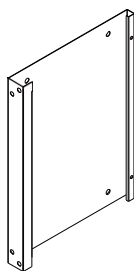

Külgpaneel 2 TK

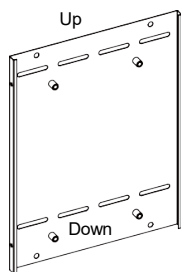

Tagapaneel 2 TK

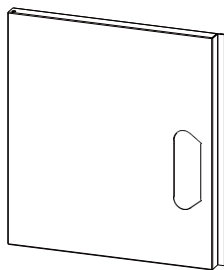

Vasakpoolne uks 1 TK

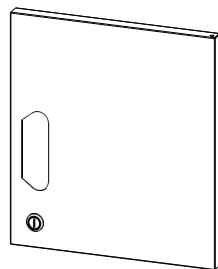

Parempoolne uks 1 TK

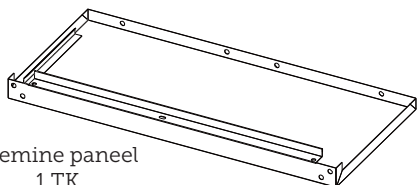

Ülemine paneel 1 TK

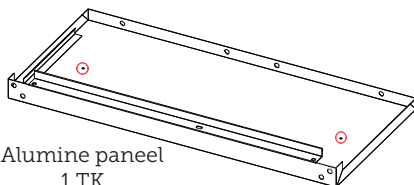

Alumine paneel 1 TK



Paigaldage ülemised kapid samamoodi nagu kõrge kapp. Ülemisel kapil puuduvad riiulid ja kummirõngad, palun ignoreerige neid kahte elementi.

# Kapp BOX 4

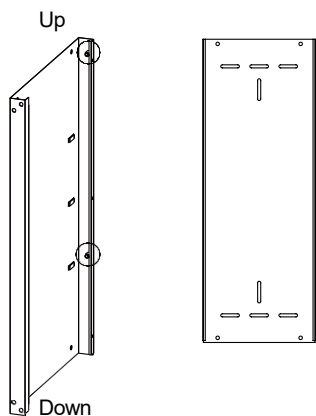

Vasakpoolne külgpaneel 1 TK

Tagapaneel 2 TK

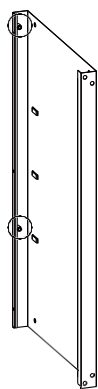

Parempoolne külgpaneel 1 TK

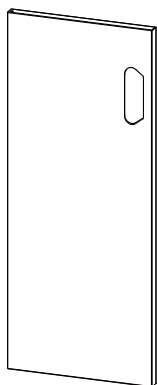

Vasakpoolne uks 1 TK

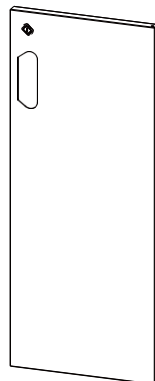

Parempoolne uks 1 TK

ET

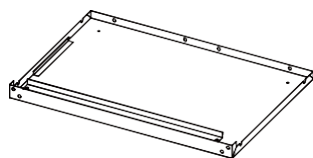

Ülemine paneel 1 TK



Palun paigaldage aluskapp vastavalt kõrge kapi kokkupanekujuhistele.



2. ja 3. sammu all ühendatakse kül- ja tagapaneel poldide ja mutritega.

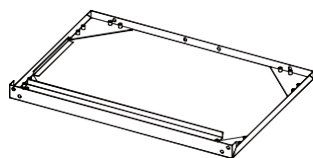

Alumine paneel 1 TK



Mutter M5  
KOGUS: 9 TK



Kruvi M5\*10  
KOGUS: 9 TK



10. sammu juures saab riiulit soovi korral reguleerida.

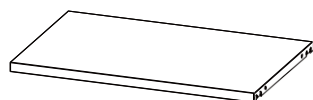

Riul 1 TK

# Ühendusavad

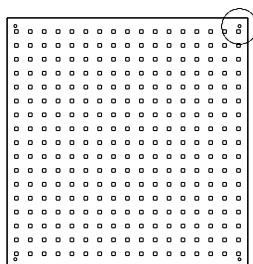
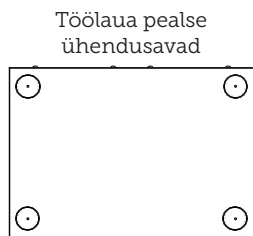
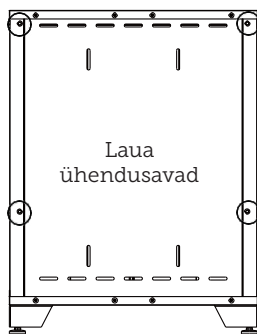
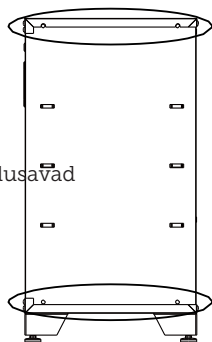
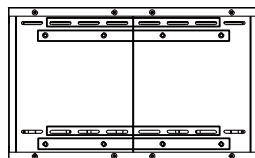
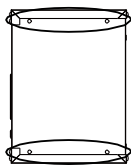
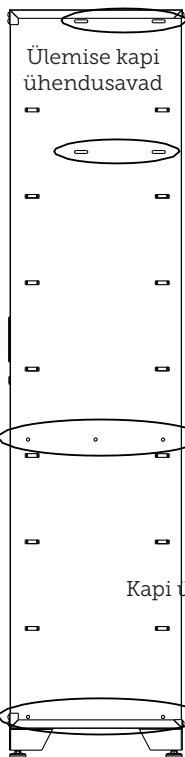

# Paigaldamine seinale

## 1. SAMM

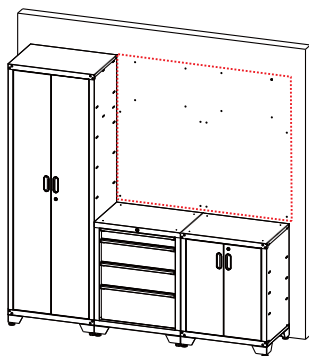

Seinapistik,  
KOGUS:16 TK

Planeerige tööriistakapi paigutus, määrake tööriistalaua ja ülemise kapi vahelise ühendusava asukoht, seejärel kinnitage seinapistik. Kõrge kapi ja aluskapi jalgu saab tõsta ja seinapistiku asukoht võib olla veidi kõrgemal.

ET

## 2. SAMM

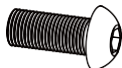

Kruvi M8\*18  
KOGUS:8 TK



Äärikmutter M8  
KOGUS:4 TK

Asetage kõrged ja ülemised kapid oma kohale, joondage need ja ühendage need paari kaupa. Sahtlitega kapi külgpaneelidesse on paigaldatud neetmutrid, mille kasutamine pole teiste kappide ühendamisel vajalik.

## 3. SAMM

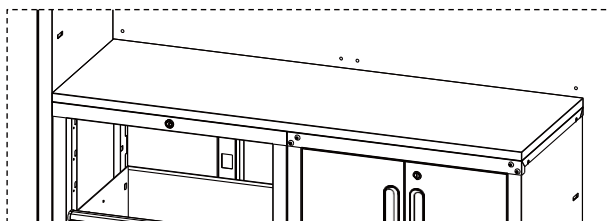

Isekeermestav kruvi  
M5\*15  
KOGUS:8 TK

Paigaldage töölaud. Keerake isekeermestavad kruvid töölauda sisse läbi kapi ülaosas olevate kinnitusaukude, veendudes, et töölaud on aluskapi välisküljega joondatud. Vajaduse korral eemaldage veel sahtlid ja paigaldage need lõpuks oma kohale tagasi.

#### 4. SAMM

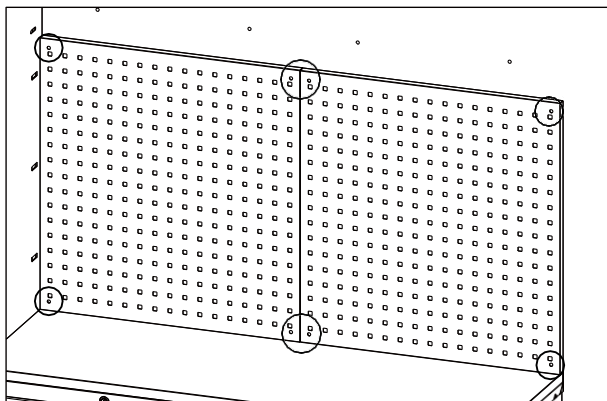

Puidukruvi M6\*60  
KOGUS:8 TK



Metallseib Ø22,8 KOGUS:8  
TK

Paigaldage tööriistalaud. Tööriistalaua neljas nurgas asuvatest ümmargustest aukudest peab saama asetada läbi isekeermestavad kruvid ja need peab saama kruvida seinal asuvasse seinapistikusse, et tööriistalaud seinalle kinnitada.

#### 5. SAMM

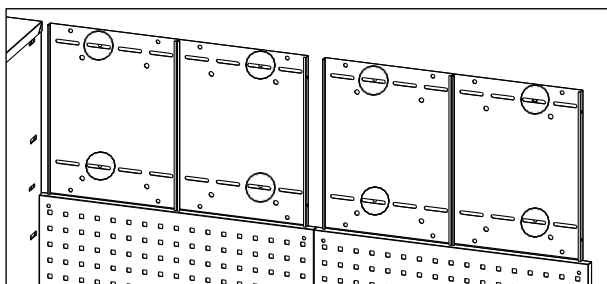

Puidukruvi M6\*60  
KOGUS:8 TK



Metallseib Ø22,8 KOGUS:8  
TK

Kapi paigaldamiseks keerake suur isekeermestav kruvi läbi seinakapi tagapaneelil oleva augu seinapistikusse, et kapi kinnitada.

#### 6. SAMM

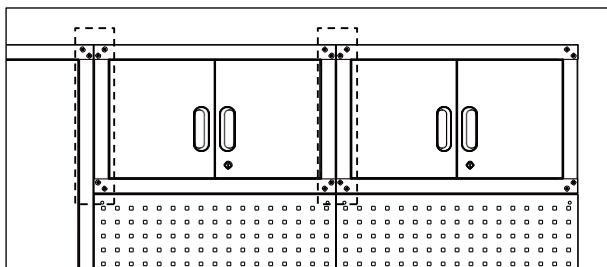

Kruvi M8\*18  
KOGUS:8 TK



Äärikmutter M8  
KOGUS:8 TK

Ülemiste kappide ja kõrge kapi vahel kasutatakse polte ja mutreid.



---

**TEENINDUSKESKUS**

Märkus. Esitage kõigi päringute korral toote mudelinumber.

Mudelinumber on näidatud selle juhendi esiküljel ja toote andmesildil.

*Järgmistel juhtudel:*

- Kaebused
  - Varuosad
  - Tagastused
  - Garantii
  - [www.schou.com](http://www.schou.com)
- 

Toodetud Hiinas

Tootja:

Schou Company A/S  
Nordager 31  
DK-6000 Kolding

Kõik õigused reserveeritud. Selle juhendi sisu ei tohi täielikult ega osaliselt reprodutseerida ühelgi viisil elektrooniliste või mehaaniliste vahenditega, nt fotokopeerida või avaldada, tõlkida või salvestada ühtelegi infokandjale ja otsingusüsteemi ilma Schou Company A/S kirjaliku loata.

---

# Mueble de almacenamiento para garaje

## INTRODUCCIÓN

Para sacar el máximo provecho a su nuevo producto, lea este manual de instrucciones antes de usarlo. Por favor, guarde este manual en caso de que necesite consultarlo en un momento posterior.

## DATOS TÉCNICOS

Armario con 2 puertas y 3 estantes.  
66 x 45,7 x 198,1 cm. (an. x pr. x al.)

2 armarios superiores con 2 puertas  
cada uno. 66 x 30,5 x 40,6 cm. (an. x pr.  
x al.)

2 chapas verticales para colgar herra-  
mientas con agujeros para ganchos  
66 x 68,4 x 2 cm (an. x pr. x al.)

Mesa de trabajo de madera maciza  
132 x 45,7 x 2,5 cm. (an. x pr. x al.)

Módulo con 4 cajones  
66 x 45,7 x 86,4 cm. (an. x pr. x al.)

Armario con 2 puertas y estante.  
66 x 45,7 x 86,4 cm. (an. x pr. x al.)

## INSTRUCCIONES ESPECIALES DE SEGURIDAD

El mueble de almacenamiento para ga-  
raje debe instalarse en posición vertical  
y fijado a una pared trasera. No se debe  
dejar que se sujete libremente.

Se recomienda que dos personas se  
encarguen de mover y montar el arma-  
rio. De lo contrario, pueden producirse  
lesiones en la espalda o de otro tipo.

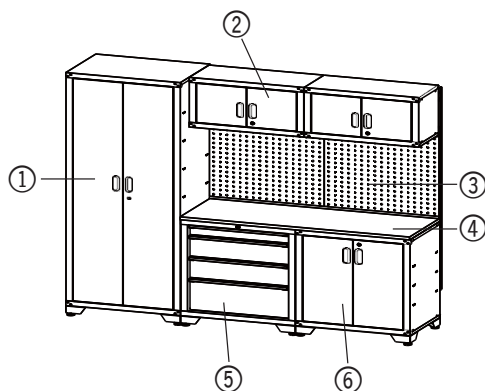

## COMPONENTES DEL MUEBLE DE ALMACENAMIENTO PARA GARAJE

1. Armario con 2 puertas y 3 estantes
2. 2 armarios superiores
3. 2 chapas verticales para colgar herramientas
4. Mesa de trabajo
5. Módulo con 4 cajones
6. Armario con 2 puertas y estante

# Piezas

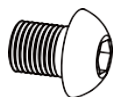

Tornillo  
M8\*10

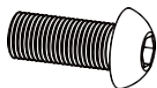

Tornillo  
M8\*18



Tuerca con  
reborde M8



Tornillo  
M5\*10



Tuerca  
M5



Tornillo para madera  
M6\*60

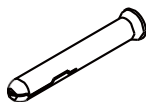

Taco



Arandela metálica  
Ø22,8



Tornillo autorroscante  
M5\*15

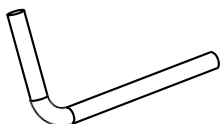

Bisagra de  
puerta

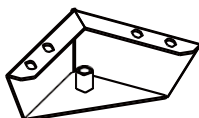

Pata niveladora  
de acero

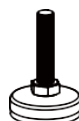

Nivelador  
ajustable  
roscado

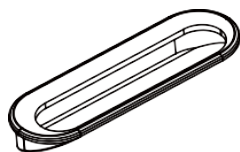

Tirador



Anillo de goma



Llave  
Allen

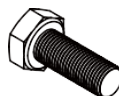

Tornillo  
M6\*16



Arandela me-  
tálica Ø12,5



Arandela de  
bisagra de  
puerta

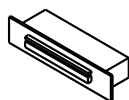

Tope para  
puerta



Llave

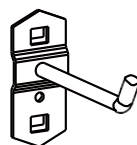

Gancho

ES

## Lista de piezas

	Caja1	Caja2	Caja3	Caja4	Caja5	Caja6
Nombre / Cantidad						
Tornillo M8*10	16	16	16	16	0	0
Tornillo M8*18	0	4	4	4	4	0
Tuerca con reborde M8	16	20	20	20	0	0
Tornillo M5*10	18	6	6	9	0	0
Tuerca M5	6	2	2	9	0	0
Tornillo M6*16	16	0	0	16	16	0
Arandela metálica Ø12,5	16	0	0	16	16	0
Tornillo para madera M6*60	0	4	4	0	8	0
Taco	0	4	4	0	8	0
Arandela metálica Ø22,8	0	4	4	0	8	0
Tornillo autorroscante M5*15	0	0	0	4	4	0
Bisagra de puerta	4	4	4	4	0	0
Arandela de bisagra de puerta	4	4	4	4	0	0
Pata niveladora de acero	4	0	0	4	4	0
Nivelador ajustable roscado	4	0	0	4	4	0
Tirador	2	2	2	2	0	0
Tope para puerta	4	4	4	4	0	0
Anillo de goma	1	0	0	0	0	0
Llave Allen	0	0	0	0	1	0
Llave	2	2	2	2	2	0
Gancho	0	0	0	0	10	0

# Montaje

## Armario alto CAJA1

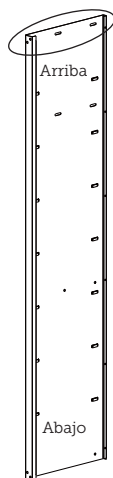

Panel lateral izquierdo 1 ud.



Panel trasero 2 uds.

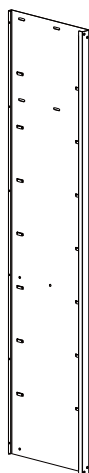

Panel lateral derecho 1 ud.

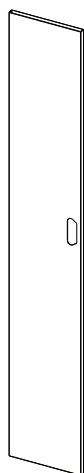

Puerta izquierda 1 ud.

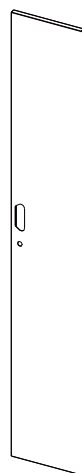

Puerta derecha 1 ud.

ES

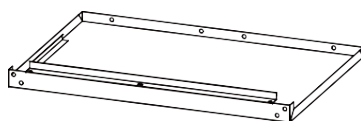

Panel superior 1 ud.

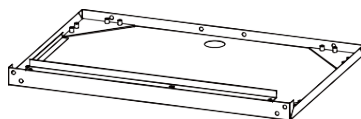

Panel inferior 1 ud.

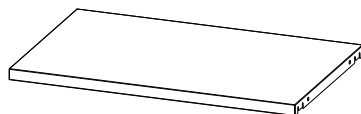

Estante 3 uds.

### PASO 1

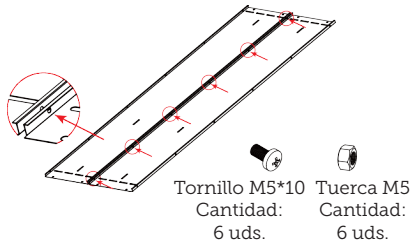

Coloque los dos paneles traseros en posición horizontal y conéctelos con tornillos M5\*10 y tuercas. Observe que los agujeros de los extremos superior e inferior estén en la misma posición.

### PASO 2

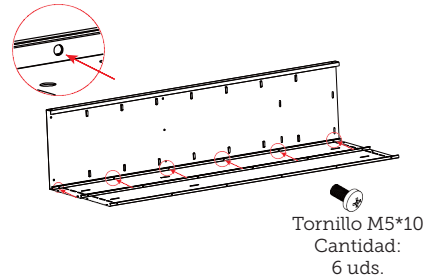

Coloque el panel izquierdo como se muestra, y conéctelo con el panel trasero con tornillos M5\*10. Preste atención a la posición de los agujeros de los extremos superior e inferior.

### PASO 3

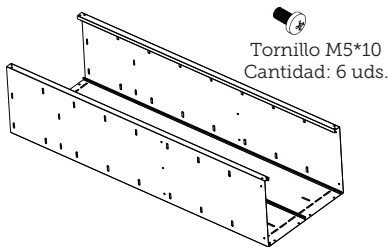

Instale el panel lateral derecho como se indica en el segundo paso. Preste atención a la posición de los agujeros del extremo superior e inferior; las dos chapas laterales son simétricas.

### PASO 4

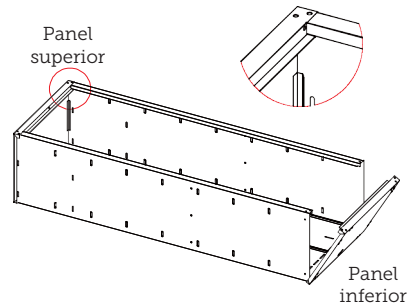

Para instalar los paneles superior e inferior, los paneles laterales deben introducirse entre las líneas triangulares de la parte interior de los paneles superior e inferior y los laterales. Un extremo de los cuatro agujeros redondos de la placa lateral es el extremo superior.

## PASO 5

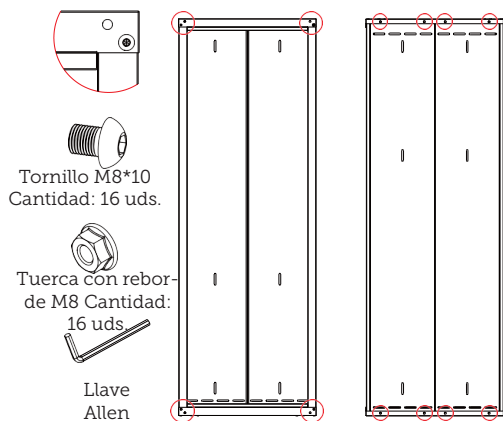

Atornille los paneles superior e inferior a los paneles traseros laterales.

## PASO 7

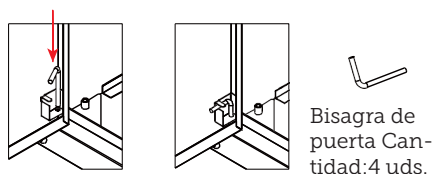

Para instalar la puerta izquierda, alinee el orificio de la bisagra de puerta en la parte inferior de la puerta izquierda con el centro de la arandela de bisagra de puerta en el lado izquierdo de la chapa inferior; introduzca la bisagra de puerta y luego fije la bisagra de puerta a la arandela de bisagra. Instale la bisagra de puerta y la puerta derecha de la misma manera.

## PASO 6

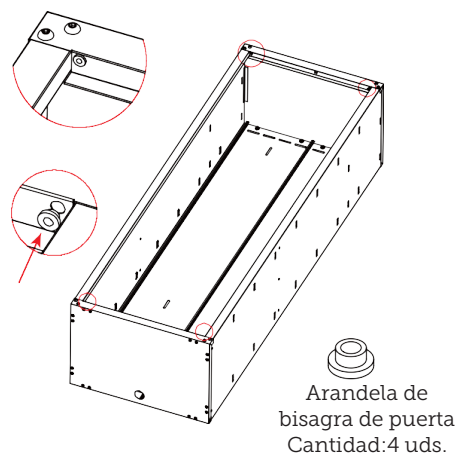

Instale la arandela de bisagra de puerta en las cuatro esquinas de las placas superior e inferior.

## PASO 8

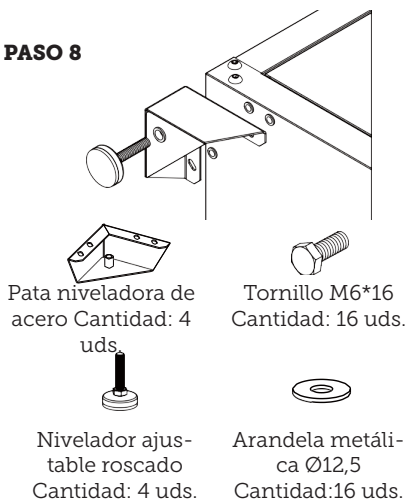

Atornille el nivelador ajustable roscado en la parte inferior de la pata niveladora de acero y utilice 4 tornillos M6\*16 para fijar la pata niveladora de acero a la parte inferior del panel inferior, de forma que el lado exterior quede alineado con el panel inferior. Instale las otras tres patas de la misma manera.

ES

## PASO 9

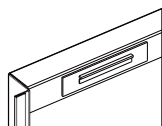

Instale el tope para puerta.

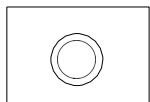

Instale el anillo de goma.

La goma se instala en la parte trasera del panel inferior.



Tope para puerta  
Cantidad:1 ud.



Tirador  
Cantidad:1 ud.



Anillo de goma  
Cantidad:1 ud.

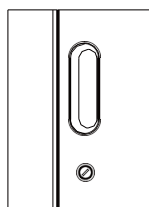

Instale el tirador.

## PASO 10

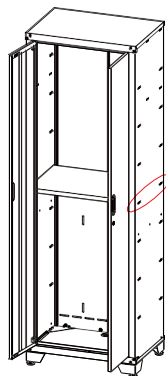

Ponga el armario en posición vertical, instale uno de los estantes en el centro del armario (para cerrar la puerta), y los otros dos estantes donde sea conveniente.

## Armarios superiores CAJAS 2 y 3

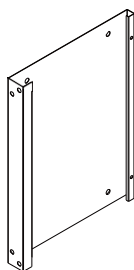

Panel lateral  
2 uds.

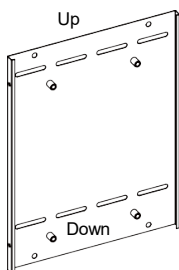

Panel trasero  
2 uds.

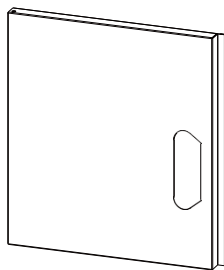

Puerta izquierda  
1 ud.

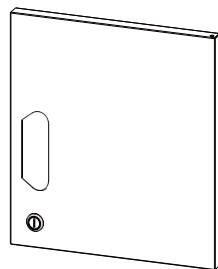

Puerta derecha  
1 ud.

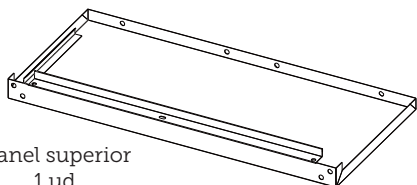

Panel superior  
1 ud.

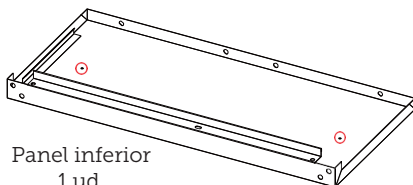

Panel inferior  
1 ud.



Instale los armarios superiores igual que el armario alto. El armario superior no tiene estantes ni anillos de goma.



# Armario CAJA 4

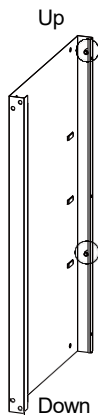

Panel lateral izquierdo 1 ud.

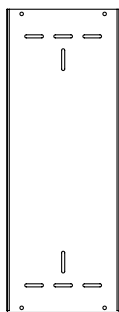

Panel trasero 2 ud.

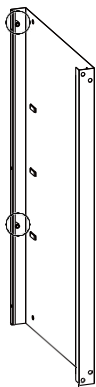

Panel lateral derecho 1 ud.

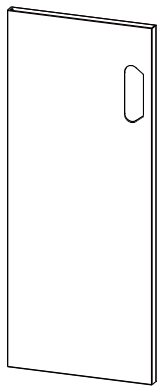

Puerta izquierda 1 ud.

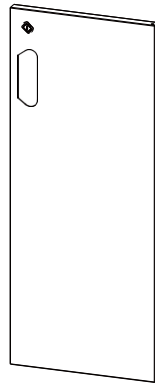

Puerta derecha 1 ud.

ES

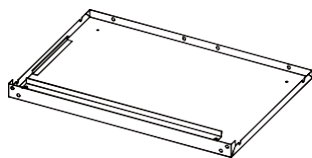

Panel superior 1 ud.



Instale el armario base siguiendo las instrucciones de montaje del armario alto.



En los pasos 2 y 3, el panel lateral y el panel trasero se conectan con tornillos y tuercas.

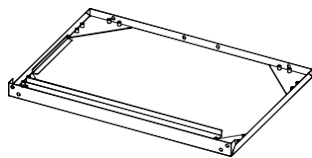

Panel inferior 1 ud.



Tuerca M5  
Cantidad:  
9 uds.



Tornillo M5\*10  
Cantidad:  
9 uds.



En el paso 10 el estante se puede ajustar según se desee.

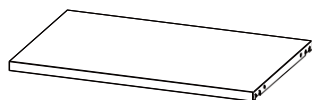

Estante 1 uds.

# Orificios de conexión

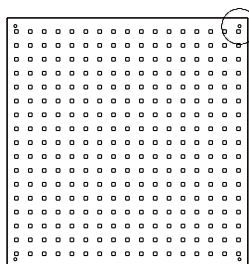
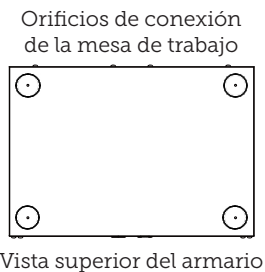
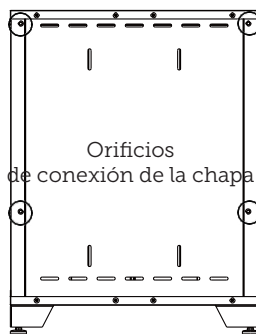
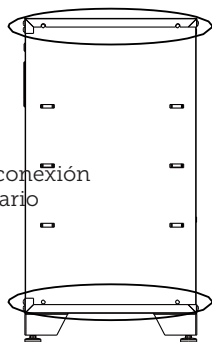
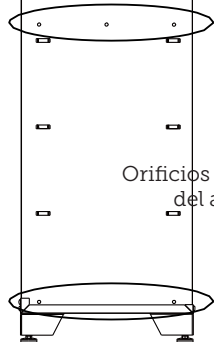
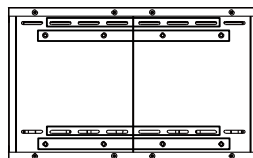
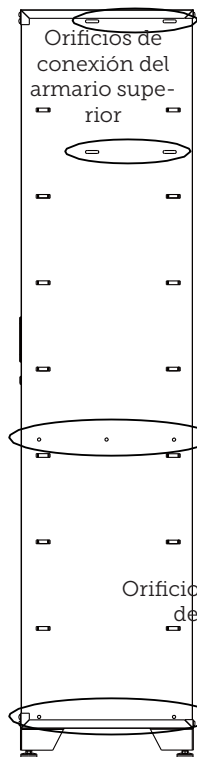

# Montaje en la pared

## PASO 1

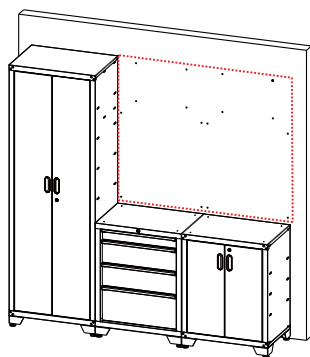

Taco,  
Cantidad:16 uds.

Planifique la colocación del armario de herramientas, determine la posición del orificio de conexión entre la chapa vertical para colgar herramientas y el armario superior; a continuación, instale el taco.

Las patas del armario alto y del armario base se pueden elevar, y la posición del taco puede ser un poco más alta.

ES

## PASO 2

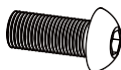

Tornillo M8\*18  
Cantidad:8 uds.



Tuerca con reborde M8  
Cantidad: 4 uds.

Coloque el armario alto y los armarios superiores en sus respectivas posiciones, alinéelos y conéctelos por parejas. Se han instalado tuercas remachables en los paneles laterales del módulo con cajones, y no se necesitan tuercas para la conexión en el centro.

## PASO 3

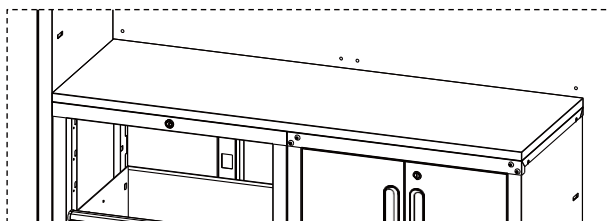

Tornillo autorroscante  
M5\*15  
Cantidad:8 uds.

Instale la mesa de trabajo. Atornille los tornillos autorroscantes en la mesa de trabajo a través de los orificios de montaje de la parte superior del armario, asegurándose de que la mesa de trabajo esté alineada con el exterior del armario base.

Retire más cajones si es necesario, y por último instale los cajones en su sitio.

#### PASO 4

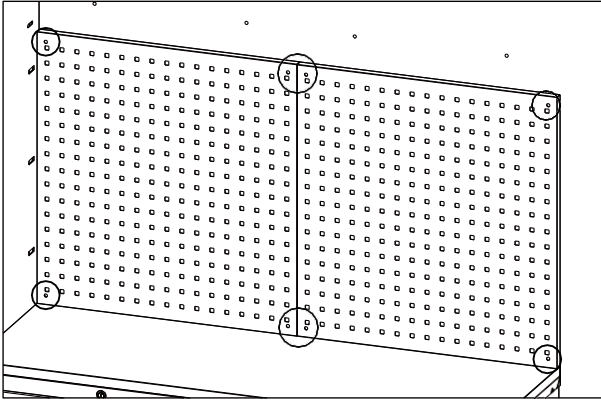

Tornillo para madera  
M6\*60  
Cantidad:8 uds.



Arandela metálica Ø22,8  
Cantidad:8 uds.

Instale la chapa vertical para colgar herramientas. Los tornillos autorroscantes grandes deben atravesar los agujeros redondos de las cuatro esquinas de la chapa vertical para colgar herramientas y atornillarse a la pared con el taco para instalar la chapa vertical para colgar herramientas en la pared.

#### PASO 5

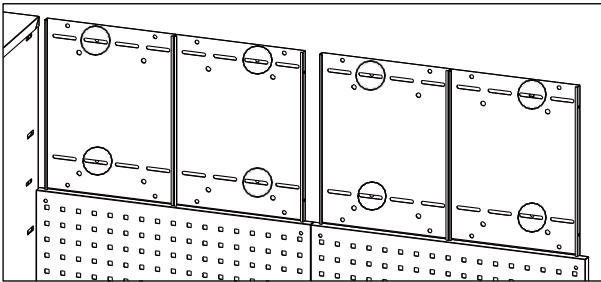

Tornillo para madera  
M6\*60  
Cantidad:8 uds.



Arandela metálica Ø22,8  
Cantidad:8 uds.

Para instalar el armario en la pared, atornille el tornillo autorroscante grande a través del orificio del panel trasero del armario en el taco.

#### PASO 6

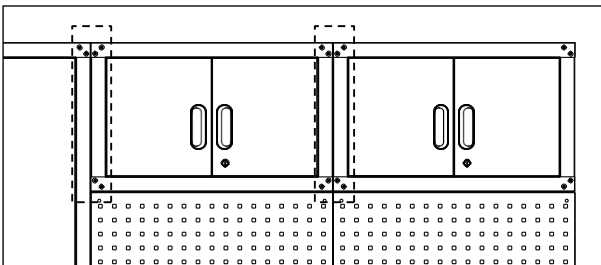

Tornillo M8\*18  
Cantidad:8 uds.



Tuerca con reborde M8  
Cantidad: 8 uds.

Se utilizan pernos y tuercas entre los armarios superiores y el armario alto.

---

**CENTRO DE ASISTENCIA**

Nota: le rogamos que indique el número de modelo del producto en todas sus consultas.

El número de modelo aparece en la parte delantera de este manual y en la placa de características del producto.

*Para:*

- Reclamaciones
- Repuestos
- Devoluciones
- Cuestiones sobre la garantía
- [www.schou.com](http://www.schou.com)

---

Fabricado en China

Fabricante:

Schou Company A/S  
Nordager 31  
DK-6000 Kolding

Todos los derechos reservados. El contenido de este manual no puede reproducirse, ni total ni parcialmente, de ninguna manera ni por medios electrónicos ni mecánicos, por ejemplo, mediante fotocopia o publicación, ni traducirse ni guardarse en un sistema de almacenamiento y recuperación de información, sin la autorización previa por escrito de Schou Company A/S.

---

# Armadiatura per garage

## INTRODUZIONE

Per ottenere le massime prestazioni dal vostro nuovo prodotto, leggere le istruzioni prima dell'uso. Conservare questo manuale per un eventuale riferimento futuro.

### DATI TECNICI

Armadio a 2 ante con 3 ripiani.  
66 x 45,7 x 198,1 cm. (LxPxA)

2 pensili superiori a 2 ante;  
66 x 30,5 x 40,6 cm. (LxPxA)

2 pannelli per attrezzi con fori per ganci ①  
66 x 68,4 x 2 cm. (LxPxA)

Piano di lavoro in legno massiccio  
132 x 45,7 x 2,5 cm. (LxPxA)

Modulo con 4 cassetti  
66 x 45,7 x 86,4 cm. (LxPxA)

Armadietto a 2 ante con ripiano.  
66 x 45,7 x 86,4 cm. (LxPxA)

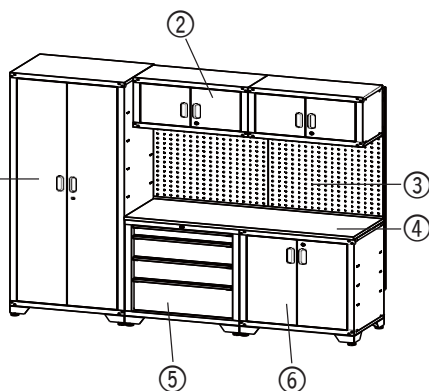

### ISTRUZIONI SPECIALI DI SICUREZZA

L'armadiatura per garage deve essere installata in posizione verticale, assicurata a una parete posteriore. Si raccomanda di non lasciarla solo appoggiata.

Per spostare, assemblare e montare l'armadio, è consigliabile la collaborazione di due persone. La mancata osservanza di questa precauzione può causare lesioni alla schiena o di altro tipo.

### PARTI DELL'ARMADIATURA PER GARAGE

1. Armadio a 2 ante con 3 ripiani
2. 2 pensili
3. 2 pannelli per utensili
4. Banco da lavoro
5. Modulo con 4 cassetti
6. Armadietto a 2 ante con un ripiano

## Parti

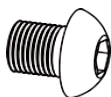

Vite M8\*10

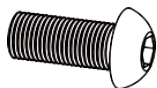

Vite M8\*18



Dado flangiato M8



Vite M5\*10



Dado M5



Vite per legno M6\*60

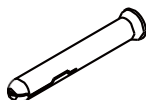

Tassello



Rondella metallica Ø22,8



Vite autofilettante M5\*15

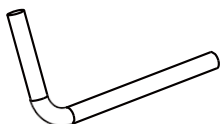

Cerniera per anta

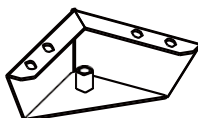

Gamba di livellamento in acciaio

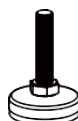

Livellatore regolabile filettato

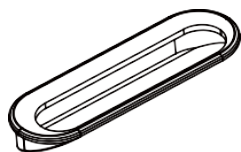

Impugnatura



Anello in gomma



Chiave a brugola



Vite M6\*16



Rondella metallica Ø12,5



Rondella per cerniera dell'anta

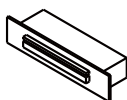

Fermaporta



Chiavi

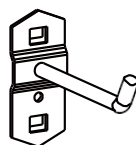

Gancio

## Elenco delle parti

	Scato- la 1	Scato- la 2	Scato- la 3	Scato- la 4	Scato- la 5	Scato- la 6
Nome / Quantità						
Vite M8*10	16	16	16	16	0	0
Vite M8*18	0	4	4	4	4	0
Dado flangiato M8	16	20	20	20	0	0
Vite M5*10	18	6	6	9	0	0
Dado M5	6	2	2	9	0	0
Vite M6*16	16	0	0	16	16	0
Rondella metallica Ø12,5	16	0	0	16	16	0
Vite per legno M6*60	0	4	4	0	8	0
Tassello	0	4	4	0	8	0
Rondella metallica Ø22,8	0	4	4	0	8	0
Vite autofilettante M5*15	0	0	0	4	4	0
Cerniera per anta	4	4	4	4	0	0
Rondella per cer- niera dell'anta	4	4	4	4	0	0
Gamba di livella- mento in acciaio	4	0	0	4	4	0
Livellatore regola- bile filettato	4	0	0	4	4	0
Impugnatura	2	2	2	2	0	0
Fermaporta	4	4	4	4	0	0
Anello in gomma	1	0	0	0	0	0
Chiave a brugola	0	0	0	0	1	0
Chiavi	2	2	2	2	2	0
Gancio	0	0	0	0	10	0



# MONTAGGIO

## Armadio alto SCATOLA 1

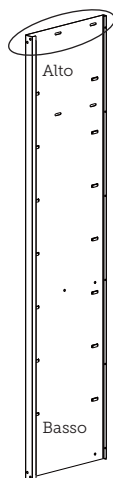

Pannello laterale sinistro  
1 pz



Pannello posteriore  
2 pezzi

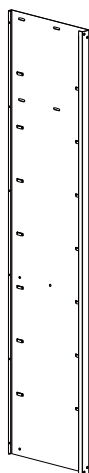

Pannello laterale destro 1 pz

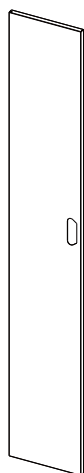

Anta sinistra  
1 pz

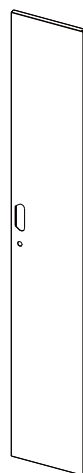

Anta destra  
1 pz

IT

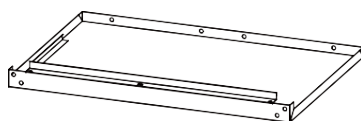

Pannello superiore 1 pz

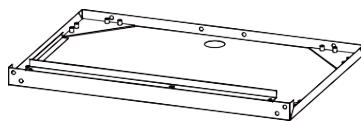

Pannello inferiore 1 pz

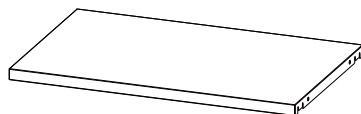

Scaffale 3 pezzi

### PASSO 1

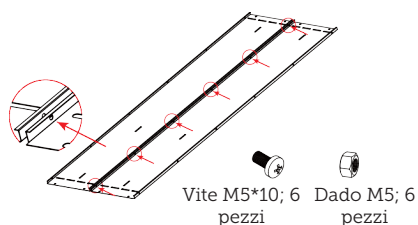

Posare in piano i due pannelli posteriori e collegarli con viti e dadi M5\*10. Si noti che i fori di estremità superiore e inferiore sono nella stessa posizione.

### PASSO 2

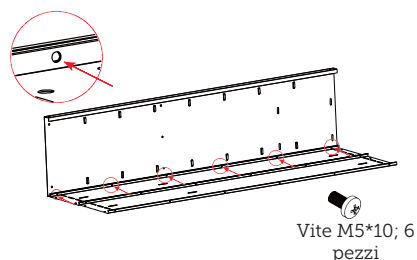

Posizionare il pannello sinistro come illustrato e collegarlo al pannello posteriore con viti M5\*10. Prestare attenzione alla posizione dei fori dell'estremità superiore e inferiore.

### PASSO 3

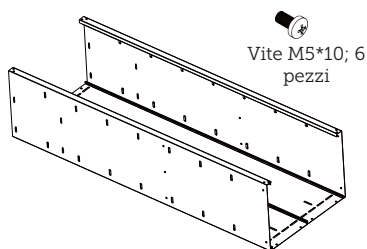

Installare il pannello laterale destro come indicato nel secondo passo. Prestare attenzione alla posizione dei fori dell'estremità superiore e inferiore: i due fianchi sono simmetrici.

### PASSO 4

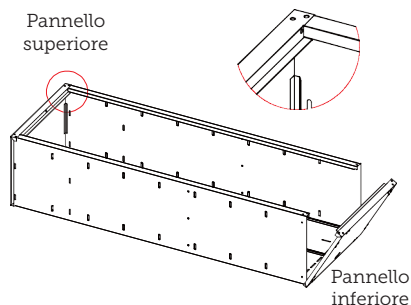

Per installare il pannello superiore e quello inferiore, i pannelli laterali devono essere inseriti tra le linee triangolari sul lato interno del pannello superiore e inferiore e i lati. Un'estremità dei quattro fori rotondi del fianco corrisponde all'estremità superiore.

## PASSO 5

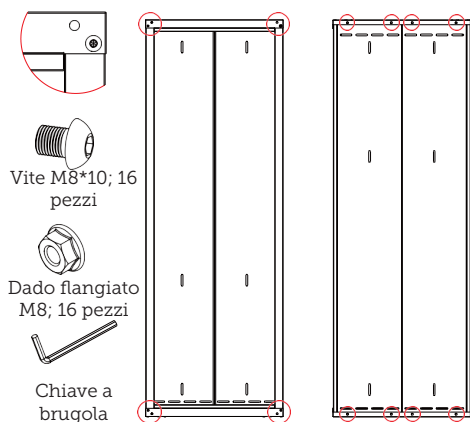

Avvitare i pannelli superiore e inferiore ai pannelli posteriori laterali.

## PASSO 6

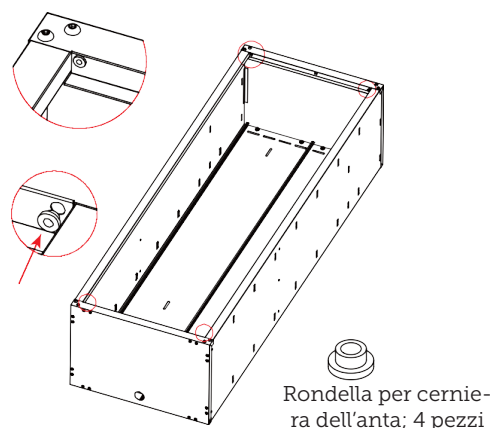

Installare la rondella per la cerniera della porta sui quattro angoli dei pannelli superiore e inferiore.

IT

## PASSO 7

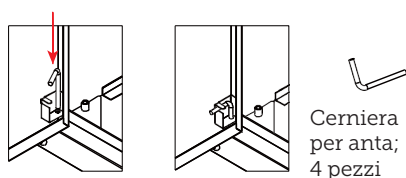

Per installare l'anta sinistra, allineare il foro della cerniera dell'anta, posto nella parte bassa dell'anta sinistra, con il centro della rondella della cerniera sul lato sinistro del pannello inferiore; inserire la cerniera dell'anta e fissarla contro la rondella della cerniera dell'anta. Installare la cerniera e l'anta destra procedendo nello stesso modo.

## PASSO 8

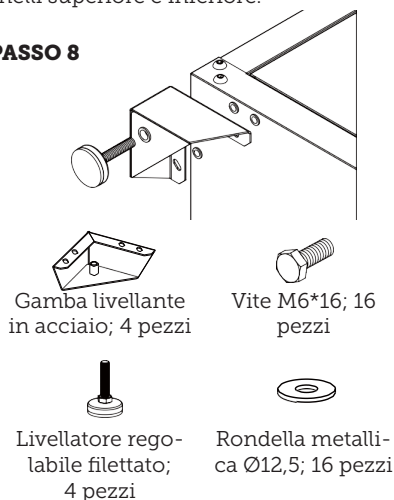

Avvitare il livellatore regolabile filettato nella parte inferiore della gamba di livellamento in acciaio e utilizzare 4 viti M6\*16 per fissare la gamba di livellamento in acciaio alla parte inferiore del pannello inferiore, in modo che il lato esterno sia allineato con il pannello inferiore. Installare gli altri tre piedini nello stesso modo.

## PASSO 9

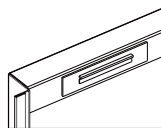

Installare il  
fermaporta

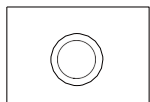

Installare l'anello  
di gomma

L'anello di gomma è installato sul retro  
del pannello inferiore.



Fermaporta; 1 pz Maniglia; 1 pz Anello di gomma;  
1 pz

## PASSO 10

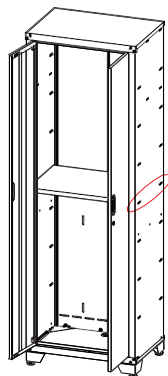

Disporre l'armadio in posizione verti-  
cale; installare uno dei ripiani al centro  
dell'armadio (per bloccare l'anta) e gli  
altri due ripiani dove è più comodo.

## Pensili SCATOLE 2 e 3

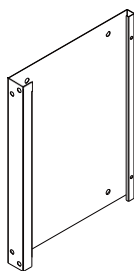

Pannello laterale  
2 pezzi

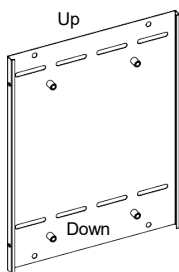

Pannello poste-  
riore 2 pezzi

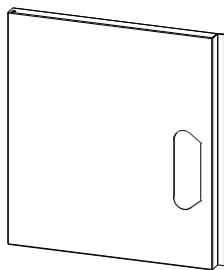

Anta sinistra  
1 pz

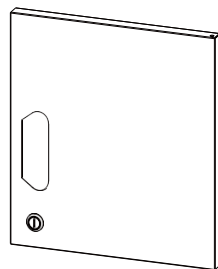

Anta destra 1 pz

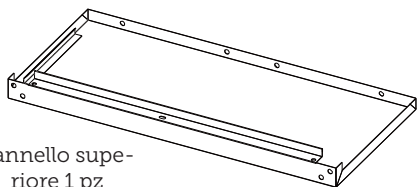

Pannello supe-  
riore 1 pz

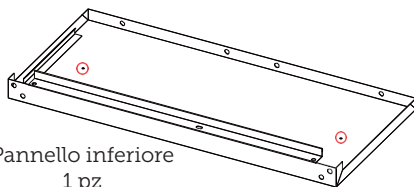

Pannello inferiore  
1 pz



Per installare i pensili procedere come per l'armadio alto. Il pensile è privo di ripiani  
e di anelli di gomma; si prega di ignorare questi due elementi.

# Armadietto SCATOLA 4

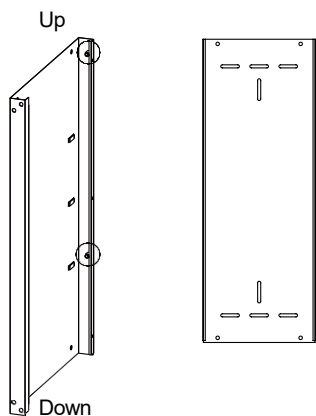

Pannello laterale  
sinistro 1 pz

Pannello poste-  
riore 2 pz

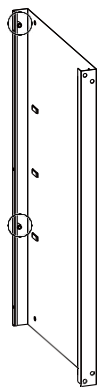

Pannello laterale  
destro 1 pz

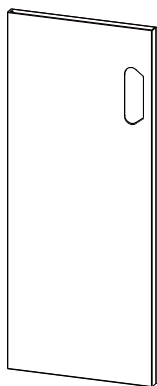

Anta  
sinistra  
1 pz

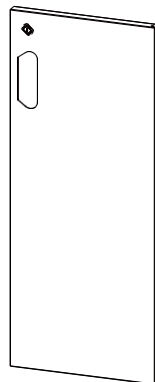

Anta destra  
1 pz

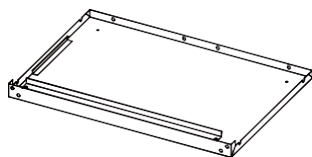

Pannello superiore 1 pz

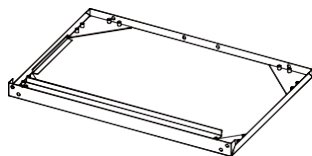

Pannello inferiore 1 pz

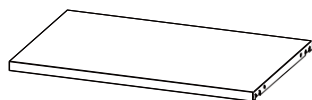

Scaffale 1 pezzi



Installare l'armadietto basso seguendo le istruzioni di montaggio dell'armadio alto.



Nei passi 2 e 3 il pannello laterale e il pannello posteriore vengono collegati mediante bulloni e dadi.



Dado M5;  
9 pezzi



Vite M5\*10;  
9 pezzi



Passo 10: il ripiano può essere regolato a piacere.

# Fori di giunzione

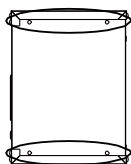
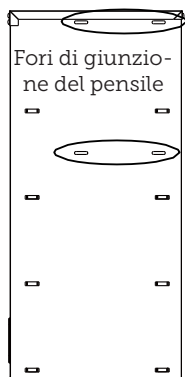

Vista laterale del pensile

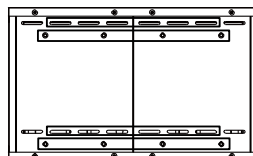

Vista posteriore del pensile



Vista destra dell'armadio alto

Fori di giunzione dell'armadio

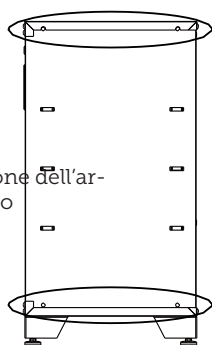

Vista laterale dell'armadietto basso



Fori di giunzione dello schienale

Vista posteriore dell'armadietto basso

Fori di giunzione al piano di lavoro

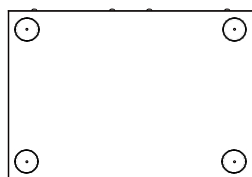

Vista dall'alto dell'armadio

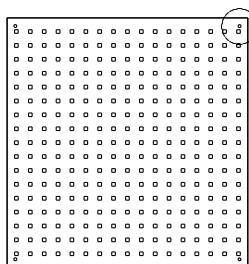

Pannello portautensili

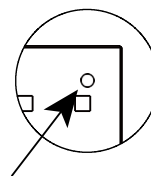

Foro di giunzione alla parete

# Montaggio a parete

## PASSO 1

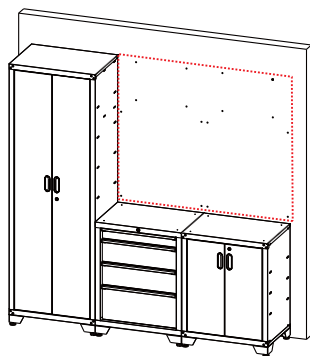

Tassello; 16 pezzi

Pianificare la collocazione dell'armadiatura portautensili; determinare la posizione del foro di giunzione tra il pannello portautensili e il pensile, quindi fissare il tassello alla parete.

I piedini dell'armadio e dell'armadio basso possono essere alzati e la posizione del tassello può essere leggermente più alta.

IT

## PASSO 2

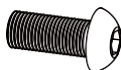

Vite M8\*18; 8 pezzi    Dado flangiato M8; 4 pezzi

Disporre l'armadio alto e i pensili nelle rispettive posizioni, allinearli e unirli a coppie. I dadi di serraggio sono stati montati sui pannelli laterali del modulo con i cassetti; non servono dadi per collegare altri armadi.

## PASSO 3

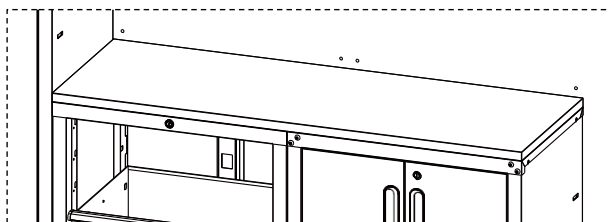

Vite autofilettante  
M5\*15; 8 pezzi

Installare il piano di lavoro. Inserire avvitando le vite autofilettanti nel piano di lavoro attraverso i fori di montaggio presenti sulla parte superiore dell'armadietto, assicurandosi che il piano di lavoro sia allineato con l'esterno dell'armadietto basso. Se necessario, rimuovere altri cassetti e rimontare i cassetti alla fine.

#### PASSO 4

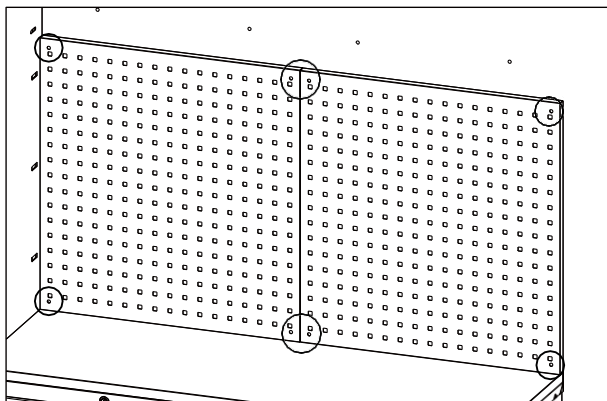

Vite per legno M6\*60; 8 pezzi



Rondella metallica Ø22,8; 8 pezzi

Installare il pannello portautensili. Inserire le viti autofilettanti di grandi dimensioni nei fori rotondi situati ai quattro angoli del pannello portautensili e avvitare nel tassello sul muro, per fissare il pannello portautensili contro il muro.

#### PASSO 5

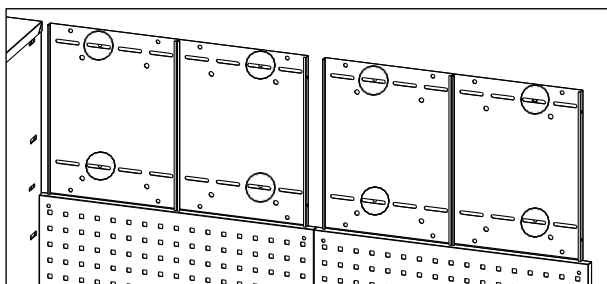

Vite per legno M6\*60; 8 pezzi



Rondella metallica Ø22,8; 8 pezzi

Per installare il pensile, avvitare la vite autofilettante grande nel foro presente nel pannello posteriore del pensile nel tassello a muro, in modo da fissare il pensile.

#### PASSO 6

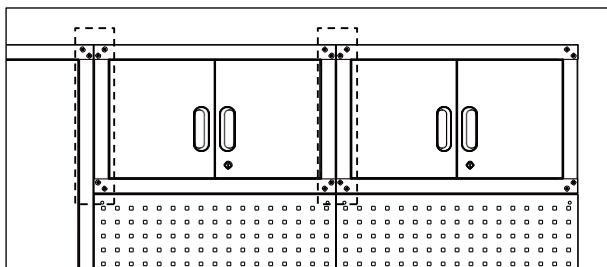

Vite M8\*18; 8 pezzi



Dado flangiato M8; 8 pezzi

Tra i pensili e l'armadio alto si utilizzano bulloni e dadi.



---

**ASSISTENZA**

Nota: si raccomanda di fornire il numero di modello del prodotto in relazione ad ogni richiesta.

Il numero di modello si trova sulla copertina del presente manuale e sulla targhetta di identificazione del prodotto.

*In caso di:*

- reclami
- parti di ricambio
- resi
- questioni riguardanti la garanzia
- [www.schou.com](http://www.schou.com)

---

Fabbricato in Cina

Produttore:

Schou Company A/S  
Nordager 31  
DK-6000 Kolding

Tutti i diritti riservati. È vietata la riproduzione del contenuto di questo manuale, totale o parziale, con qualsiasi mezzo, elettronico o meccanico, ad esempio tramite fotocopiatura o pubblicazione, traduzione o salvataggio in archivi informatici e sistemi che ne consentano il recupero, senza autorizzazione scritta di Schou Company A/S.

---

# Garagekast

## INLEIDING

Om het beste uit uw nieuwe product te halen, gelieve deze instructies voor gebruik door te lezen. Bewaar de handleiding voor het geval u deze op een later moment wilt raadplegen.

### TECHNISCHE GEGEVENS

Kast met 2 deuren en 3 legplanken.  
66 x 45,7 x 198,1 cm. (BxDxH)

2 bovenkasten met elk 2 deuren.  
66 x 30,5 x 40,6 cm. (BxDxH)

2 gereedschapspanelen met gaten voor haken  
66 x 68,4 x 2 cm. (BxDxH)

Werkblad van massief hout  
132 x 45,7 x 2,5 cm. (BxDxH)

Ladeblok met 4 lades  
66 x 45,7 x 86,4 cm. (BxDxH)

Kast met 2 deuren en legplank.  
66 x 45,7 x 86,4 cm. (BxDxH)

### SPECIALE VEILIGHEIDSINSTRUCTIES

De garagekast moet rechtop staan en aan een achterwand worden bevestigd. Nooit de kast vrijstaand neerzetten!

Het is raadzaam dat twee personen de kast monteren, verplaatsen en bevestigen. Anders kan rug- of ander letsel het gevolg zijn.

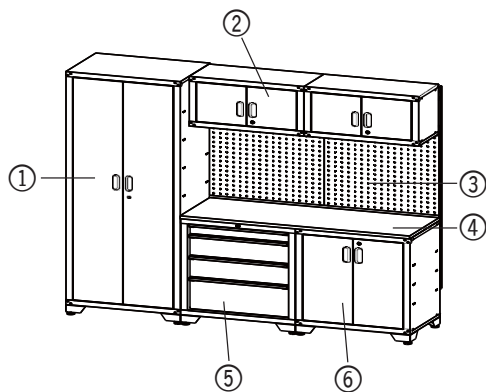

### ONDERDELEN VAN DE GARAGEKAST

1. Kast met 2 deuren en 3 legplanken
2. 2 bovenkasten
3. 2 gereedschapspanelen
4. Werkblad
5. Ladeblok met 4 lades
6. Kast met 2 deuren en legplank

# Onderdelen

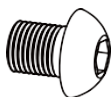

Schroef  
M8x10

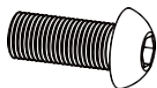

Schroef  
M8x18



Flensmoer M8



Schroef  
M5x10



Moer  
M5



Houtschroef  
M6x60

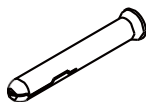

Muurplug



Metalen ring Ø22,8



Zelftappende schroef  
M5x15

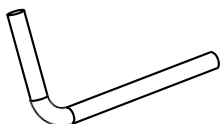

Deurschar-  
nier

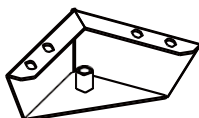

Stalen poot

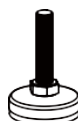

Stelpoot met  
schroefdraad

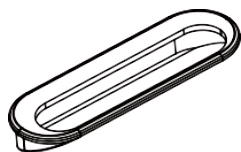

Handvat



Rubberen  
ring



Inbus-  
sleutel



Schroef  
M6x16

NL



Metalen ring  
Ø12,5



Deurschar-  
nerring

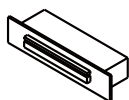

Deurstopper



Sleutel

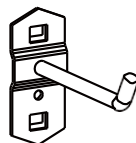

Haak

# Onderdelenlijst

	Doos 1	Doos 2	Doos 3	Doos 4	Doos 5	Doos 6
Naam/Aantal						
Schroef M8x10	16	16	16	16	0	0
Schroef M8x18	0	4	4	4	4	0
Flensmoer M8	16	20	20	20	0	0
Schroef M5x10	18	6	6	9	0	0
Moer M5	6	2	2	9	0	0
Schroef M6x16	16	0	0	16	16	0
Metalen ring Ø12,5	16	0	0	16	16	0
Houtschroef M6x60	0	4	4	0	8	0
Muurplug	0	4	4	0	8	0
Metalen ring Ø22,8	0	4	4	0	8	0
Zelftappende schroef M5x15	0	0	0	4	4	0
Deurscharnier	4	4	4	4	0	0
Deurscharnerring	4	4	4	4	0	0
Stalen poot	4	0	0	4	4	0
Stelpoot met schroefdraad	4	0	0	4	4	0
Handvat	2	2	2	2	0	0
Deurstopper	4	4	4	4	0	0
Rubberen ring	1	0	0	0	0	0
Inbussleutel	0	0	0	0	1	0
Sleutel	2	2	2	2	2	0
Haak	0	0	0	0	10	0

# Montage

## Hoge opbergkast DOOS 1

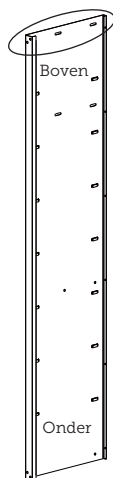

Linkerzijpaneel  
1 stuk



Achterpaneel  
2 stuks

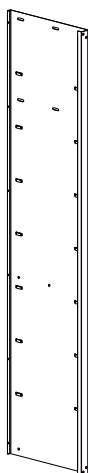

Rechterzijpaneel  
1 stuk

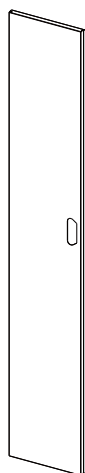

Linkerdeur  
1 stuk

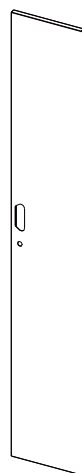

Rechterdeur  
1 stuk

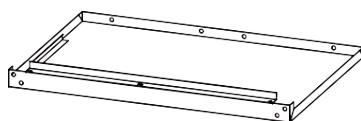

Bovenpaneel 1 stuk

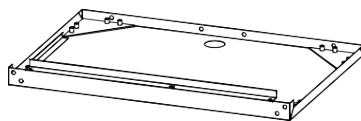

Onderpaneel 1 stuk

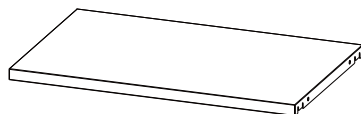

Legplank  
3 stuks

NL

### STAP 1

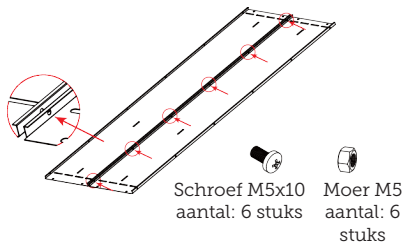

Leg de twee achterpanelen plat en verbind ze met schroeven en moeren M5x10. Let erop dat de eindgaten boven en onder zich in dezelfde positie bevinden.

### STAP 2

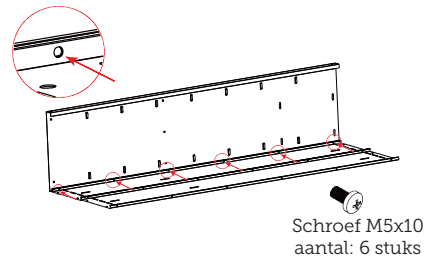

Plaats het linkerzijpaneel zoals afgebeeld, en verbind het met schroeven M5x10 met het achterpaneel. Let op de positie van de eindgaten boven en onder.

### STAP 3

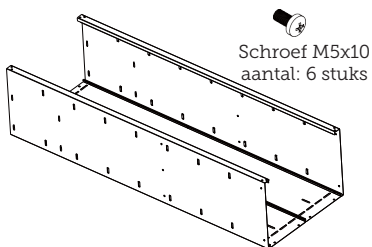

Installeer het rechterzijpaneel volgens de tweede stap. Let op de positie van de bovenste en onderste eindgaten. De twee zijplaten zijn symmetrisch.

### STAP 4

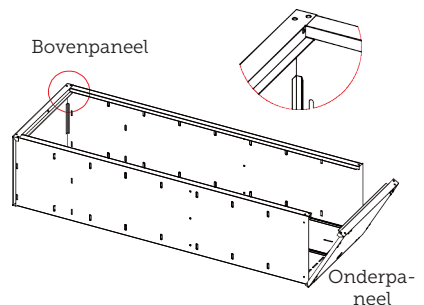

Om de boven- en onderpanelen te monteren, moet u de zijpanelen tussen de driehoeken aan de binnenzijde van de boven- en onderpanelen en de zijkanten schuiven. Het uiteinde van de zijplaat met de vier ronde gaten is het bovenste uiteinde.

## STAP 5

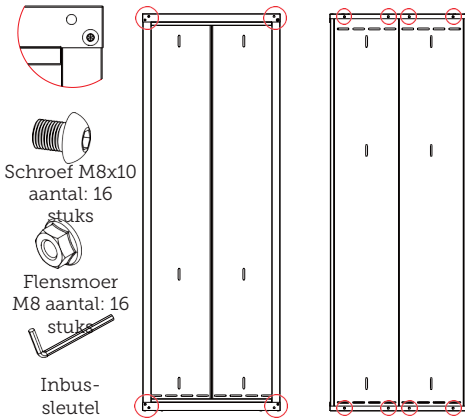

Schroef de boven- en onderpanelen aan de achterpanelen.

## STAP 6

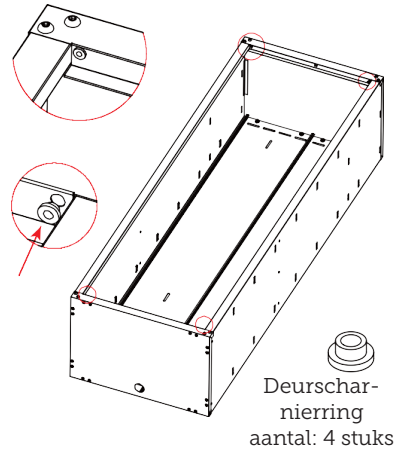

Plaats de scharnerring op de vier hoeken van het boven- en onderpaneel.

## STAP 7

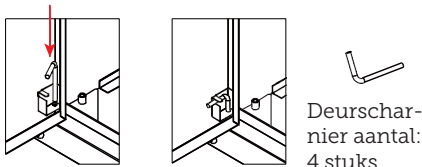

Om de linkerdeur te installeren, moet u het deurscharniergegat onderaan de linkerdeur uitlijnen met het midden van de deurscharnerring aan de linkerkant van het onderpaneel. Plaats het deurscharnier en druk het deurscharnier vervolgens vast aan de deurscharnerring. Installeer het deurscharnier en de rechterdeur op dezelfde manier.

## STAP 8

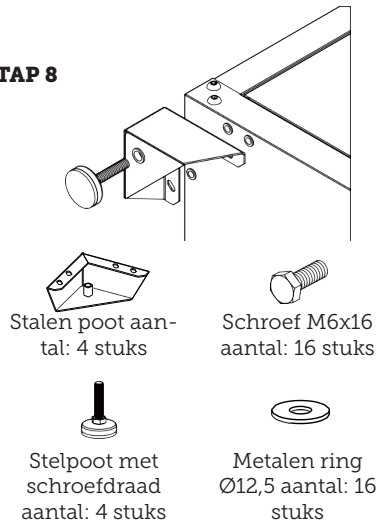

Schroef de stelpoot met schroefdraad in de onderkant van de stalen poot. Gebruik 4 schroeven M6x16 om de stalen poot aan de onderkant van het bodempaneel te bevestigen om de buitenkant uit te lijnen met het onderpaneel. Monteer de andere drie poten op dezelfde manier.

## STAP 9

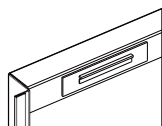

Monteer de deurstopper

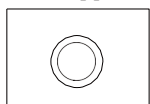

Monteer de rubberen ring

Het rubber moet aan de achterkant van het bodempaneel worden gemonteerd.

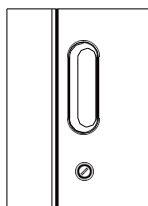

Monteer de handgreep



Deurstopper  
aantal: 1 stuk



Handgreep  
aantal: 1 stuk



Rubberen ring  
aantal: 1 stuk

## STAP 10

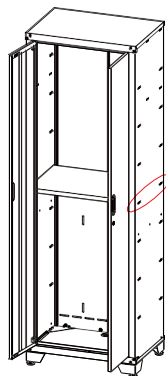

Zet de kast rechtop en leg een van de legplanken in het midden van de kast (om de deur te vergrendelen). De twee andere legplanken kunt u naar believen plaatsen.

## Bovenkasten DOOS 2 & 3

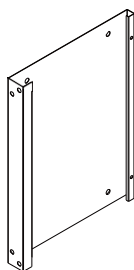

Zijpaneel 2 stuks

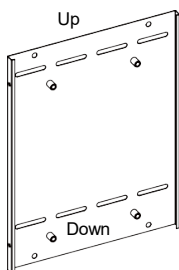

Achterpaneel  
2 stuks

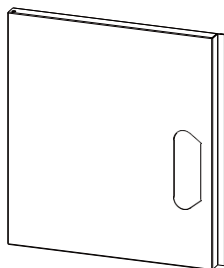

Linkerdeur  
1 stuk

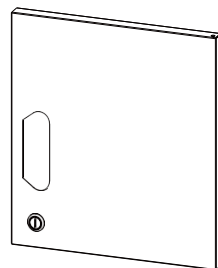

Rechterdeur  
1 stuk

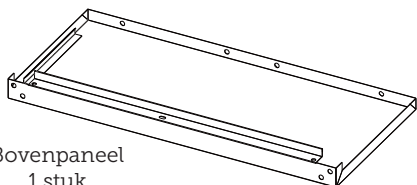

Bovenpaneel  
1 stuk

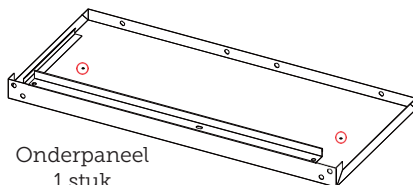

Onderpaneel  
1 stuk



Monteer de bovenkasten op dezelfde manier als de hoge kast. De bovenkast heeft geen planken en rubberen ringen. Negeer daarom deze twee items.



# Kast DOOS 4

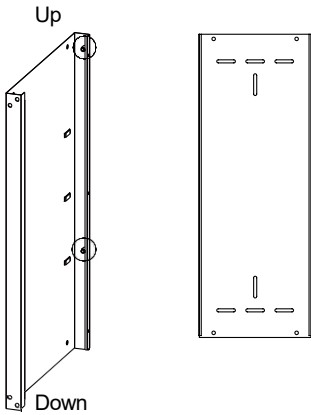

Linkerzijpaneel  
1 stuk

Achterpaneel  
2 stuk

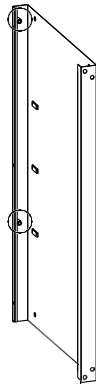

Rechterzijpaneel  
1 stuk

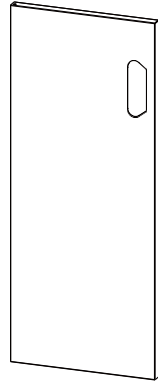

Linkerdeur  
1 stuk

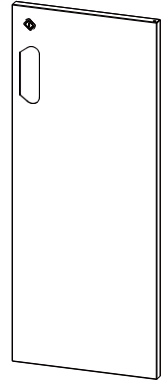

Rechterdeur  
1 stuk

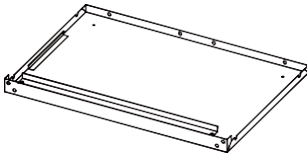

Bovenpaneel  
1 stuk

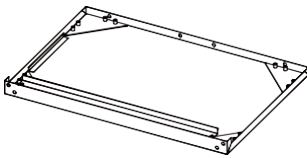

Onderpaneel  
1 stuk

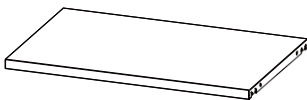

Legplank  
1 stuk



Monteer de lage kast volgens de montage-instructies van de hoge kast.

NL



In stap 2 en stap 3 moet u het zijpaneel en het achterpaneel met bouten en moeren verbinden.



Moer M5  
aantal: 9 stuks



Schroef M5x10  
aantal: 9 stuks



Stap 10: Plaats de plank waar u maar wil.

# Verbindingsgaten

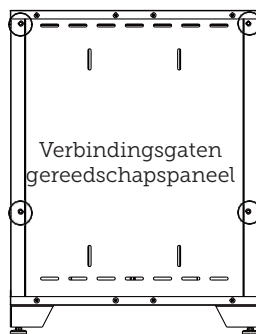
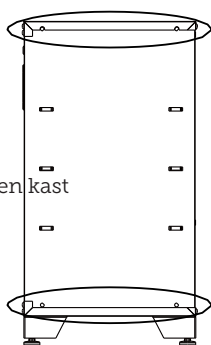
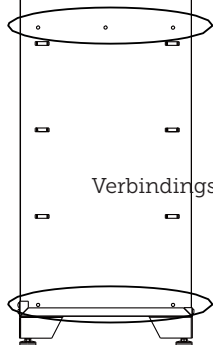
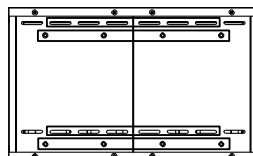
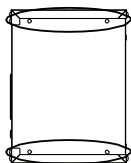

Verbindingsgaten werkblad

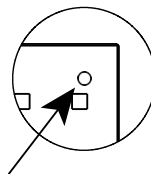
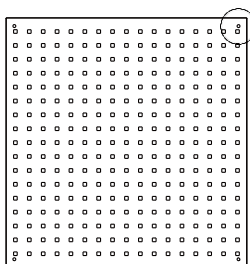
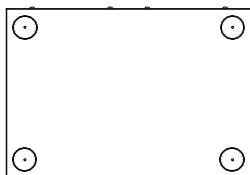

# Aan de muur bevestigen

## STAP 1

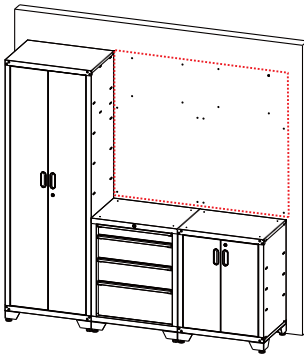

Muurplug  
aantal: 16 stuks

Bepaal de plaats van de gereedschapskast. Bepaal daarna de positie van het verbindingsgat tussen het gereedschapspaneel en de bovenkast. Bevestig vervolgens de muurplug.

De poten van de hoge kast en de onderkast kunnen worden verhoogd, en u kunt de muurplug iets hoger positioneren.

## STAP 2

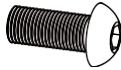

Schroef M8x18  
aantal: 8 stuks



Flensmoer M8  
aantal: 4 stuks

Plaats de hoge en de bovenkasten op hun respectieve plaatsen, lijn ze uit en verbind ze paarsgewijs. De klinkmoeren zijn op de zijpanelen van de ladekast aangebracht. U hoeft de moeren niet te gebruiken om de andere kasten te verbinden.

## STAP 3

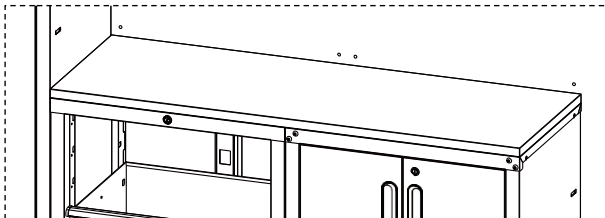

Zelf-tappende  
schroef  
M5x15  
aantal: 8 stuks

Monteer het werkblad. Schroef de zelftappende schroeven in het werkblad door de montagegaten aan de bovenkant van de kast. Zorg ervoor dat het werkblad uitgelijnd is met de buitenkant van de lage kast.

Verwijder zo nodig meer lades en plaats de lades tenslotte terug op hun plaats.

## STAP 4

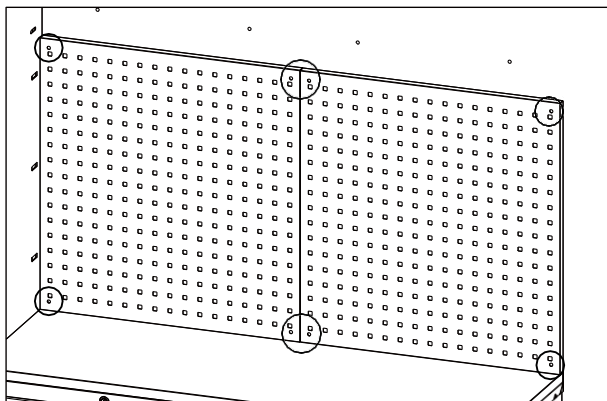

Hout Schroef M6x60  
aantal: 8 stuks



Metalen ring Ø22.8  
aantal: 8 stuks

Installeer het gereedschapspaneel. Steek de grote zelftappende schroeven door de ronde gaten op de vier hoeken van het gereedschapspaneel. Schroef ze in de muurpluggen om het gereedschapspaneel aan de muur te bevestigen.

## STAP 5

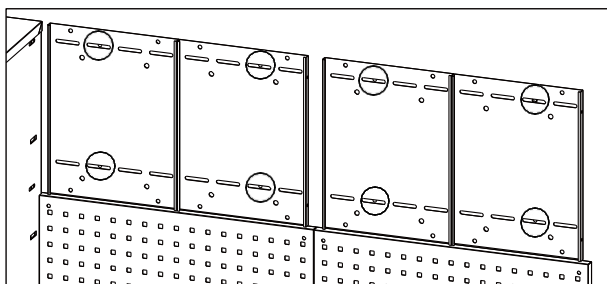

Hout Schroef M6x60  
aantal: 8 stuks



Metalen ring Ø22.8  
aantal: 8 stuks

Om de kast aan de muur te bevestigen, moet u de grote zelftappende schroef door het gat op het achterpaneel van de wandkast in de muurplug schroeven.

## STAP 6

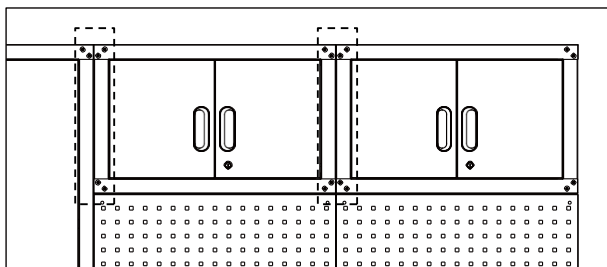

Schroef M8x18  
aantal: 8 stuks



Flensmoer M8  
aantal: 8 stuks

Gebruik bouten en moeren tussen de bovenkasten en de hoge kast.

---

**SERVICECENTRUM**

Let op: Vermeld het modelnummer van het product bij vragen die u opstuurt.

Het modelnummer wordt weergegeven op het voorblad van deze handleiding en op het typeplaatje van het product.

*Voor:*

- Klachten
  - Reserveonderdelen
  - Retourzendingen
  - Garantieproblemen
  - [www.schou.com](http://www.schou.com)
- 

Geproduceerd in China

Fabrikant:

Schou Company A/S  
Nordager 31  
DK-6000 Kolding

Alle rechten voorbehouden. De inhoud van deze handleiding mag, zonder schriftelijke toestemming van Schou Company A/S, niet op enigerlei wijze in zijn geheel of gedeeltelijk worden gereproduceerd; dat wil zeggen op elektronische of mechanische wijze, bv. door te kopiëren of publiceren, te vertalen of te bewaren in een systeem voor het opslaan en ophalen van informatie.

---

# Meuble de garage

## INTRODUCTION

Pour profiter au mieux de toutes les possibilités offertes par votre nouveau produit, veuillez lire entièrement les instructions avant toute utilisation. Veuillez également conserver ces instructions au cas où vous auriez besoin de les consulter ultérieurement.

## CARACTÉRISTIQUES TECHNIQUES

Armoire avec 2 portes et 3 étagères.  
66 x 45,7 x 198,1 cm. (l x P x H)

2 armoires supérieures avec 2 portes  
chacune. 66 x 30,5 x 40,6 cm. (l x P x H)

2 panneaux à outils avec trous pour  
crochets  
66 x 68,4 x 2 cm. (l x P x H)

Plan de travail en bois massif  
132 x 45,7 x 2,5 cm. (l x P x H)

Module avec 4 tiroirs  
66 x 45,7 x 86,4 cm. (l x P x H)

Armoire avec 2 portes et une étagère.  
66 x 45,7 x 86,4 cm. (l x D x H)

## CONSIGNES DE SÉCURITÉ PARTICULIÈRES

Le meuble de garage doit être posé à la verticale et être fixé à un mur arrière. Il ne doit pas être installé sans fixation !

Il est recommandé d'être deux pour déplacer, assembler et monter le meuble. Le non-respect de cette consigne peut entraîner des blessures au dos ou d'autres blessures.

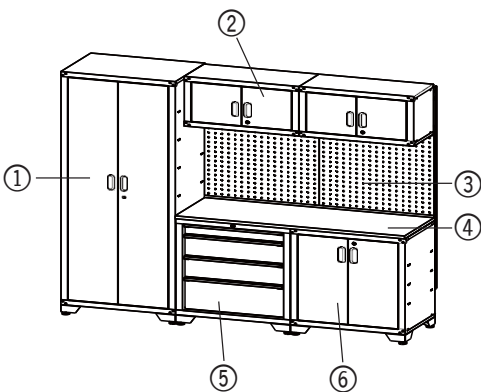

## PARTIES DU MEUBLE DE GARAGE

1. Armoire avec 2 portes et 3 étagères
2. 2 armoires supérieures
3. 2 panneaux à outils
4. Plan de travail
5. Module avec 4 tiroirs
6. Armoire avec 2 portes et une étagère

# Pièces

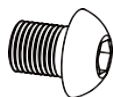

Vis M8\*10

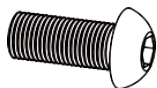

Vis M8\*18



Écrou à bride M8



Vis M5\*10



Écrou M5



Vis à bois M6\*60

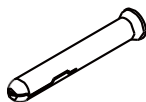

Cheville murale



Rondelle métallique Ø22,8



Vis autotaraudeuse M5\*15

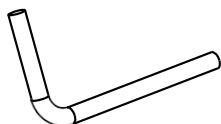

Charnière de porte

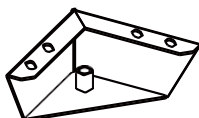

Pied de nivellement en acier

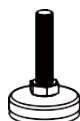

Niveleur réglable fileté

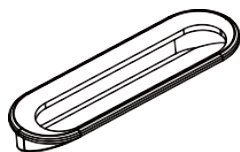

Poignée



Anneau en caoutchouc



Clé Allen



Vis M6\*16

FR



Rondelle métallique Ø12,5



Rondelle de charnière de porte

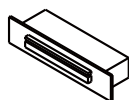

Butée de porte



Clé

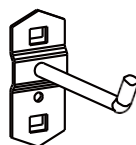

Crochet

# Liste des pièces

	Boîte 1	Boîte 2	Boîte 3	Boîte 4	Boîte 5	Boîte 6
Nom/quantité						
Vis M8*10	16	16	16	16	0	0
Vis M8*18	0	4	4	4	4	0
Écrou à bride M8	16	20	20	20	0	0
Vis M5*10	18	6	6	9	0	0
Écrou M5	6	2	2	9	0	0
Vis M6*16	16	0	0	16	16	0
Rondelle métallique Ø12,5	16	0	0	16	16	0
Vis à bois M6*60	0	4	4	0	8	0
Cheville murale	0	4	4	0	8	0
Rondelle métallique Ø22,8	0	4	4	0	8	0
Vis autotarandeuse M5*15	0	0	0	4	4	0
Charnière de porte	4	4	4	4	0	0
Rondelle de charnière de porte	4	4	4	4	0	0
Pied de nivellement en acier	4	0	0	4	4	0
Niveleur réglable fileté	4	0	0	4	4	0
Poignée	2	2	2	2	0	0
Butée de porte	4	4	4	4	0	0
Anneau en caoutchouc	1	0	0	0	0	0
Clé Allen	0	0	0	0	1	0
Clé	2	2	2	2	2	0
Crochet	0	0	0	0	10	0



# Montage

## Armoire de rangement haute BOÎTE1

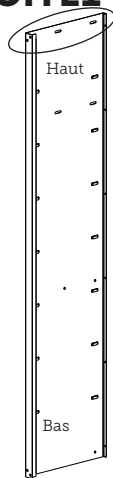

Panneau latéral gauche 1 pc.



Panneau arrière 2 pcs.

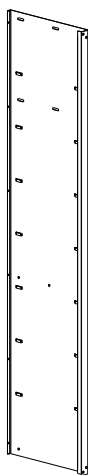

Panneau latéral droit 1 pc.

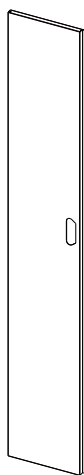

Porte gauche 1 pc.

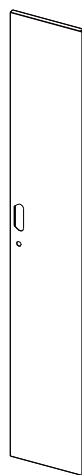

Porte droite 1 pc.

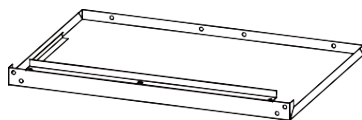

Panneau supérieur 1 pc.

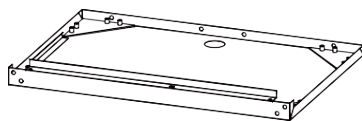

Panneau inférieur 1 pc.

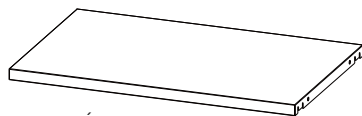

Étagère 3 pcs.

FR

### ÉTAPE 1 :

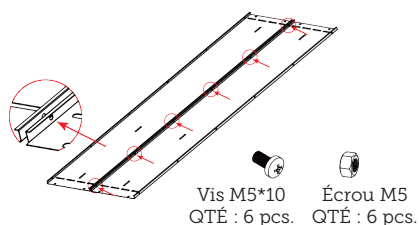

Posez les deux panneaux arrière à plat et raccordez-les avec des vis et des écrous M5\*10. Notez que les trous des extrémités supérieure et inférieure sont dans la même position.

### ÉTAPE 2 :

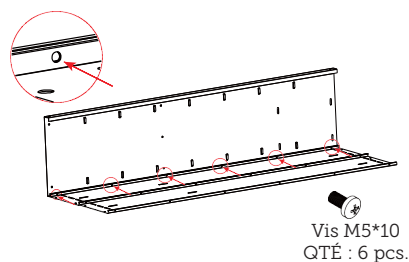

Placez le panneau gauche comme indiqué, et reliez-le au panneau arrière avec des vis M5\*10. Faites attention à la position des trous d'extrémité supérieurs et inférieurs.

### ÉTAPE 3 :

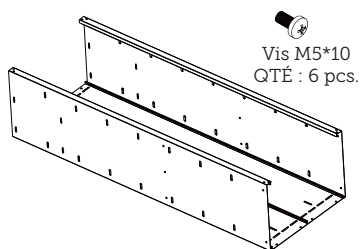

Installez le panneau latéral droit en suivant la deuxième étape. Faites attention à la position des trous d'extrémité supérieurs et inférieurs, car les deux panneaux latéraux sont symétriques.

### ÉTAPE 4 :

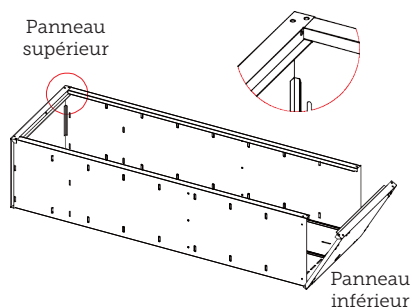

Pour installer les panneaux supérieur et inférieur, les panneaux latéraux doivent être insérés entre les lignes triangulaires situées sur la face intérieure des panneaux supérieur et inférieur et les côtés. L'une des extrémités des quatre trous ronds de la plaque latérale est l'extrémité supérieure.

## ÉTAPE 5 :

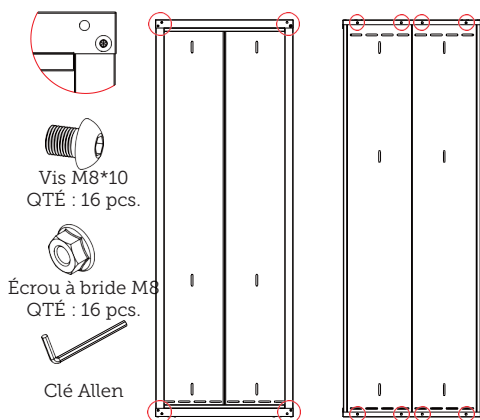

Boulonnez les panneaux supérieur et inférieur aux panneaux arrière latéraux.

## ÉTAPE 7 :

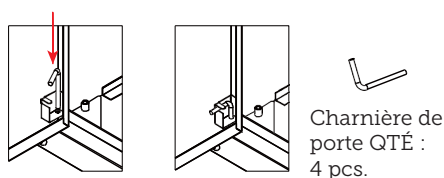

Pour installer la porte gauche, alignez le trou de la charnière de porte sur le bas de la porte gauche en plaçant le centre de la rondelle de charnière de porte sur le côté gauche de la plaque inférieure, insérez la charnière de porte, puis fixez la charnière de porte à la rondelle. Installez la charnière de la porte et la porte droite de la même manière.

## ÉTAPE 6 :

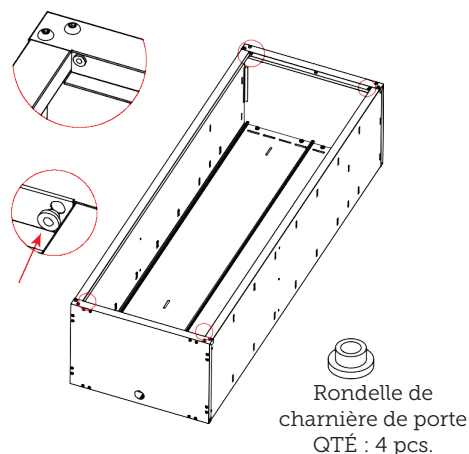

Installez les rondelles de charnière de porte aux quatre coins des plaques supérieure et inférieure.

## ÉTAPE 8 :

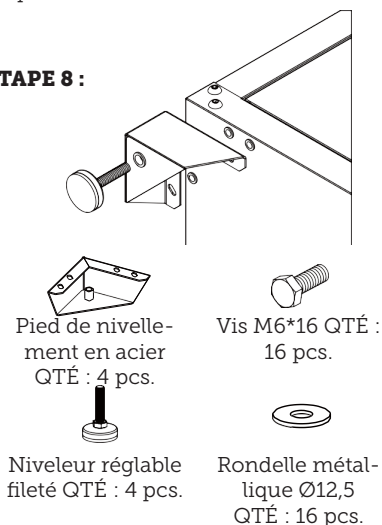

Vissez le niveleur réglable fileté dans le bas du pied de nivellement en acier, et utilisez 4 vis M6\*16 pour fixer le pied de nivellement en acier au bas du panneau inférieur, de sorte que le côté extérieur soit aligné avec le panneau inférieur. Installez les trois autres pieds de la même manière.

### ÉTAPE 9 :

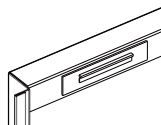

Installer le butoir de porte

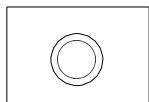

Installer l'anneau en caoutchouc

Le caoutchouc est installé à l'arrière du panneau inférieur.



Butée de porte  
QTÉ : 1 pc.



Poignée  
QTÉ : 1 pc.



Anneau en caoutchouc  
QTÉ : 1 pc.

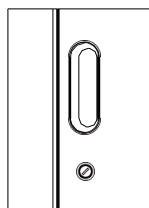

Installer la poignée

### ÉTAPE 10 :

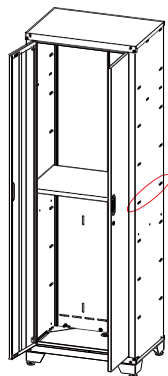

Redressez l'armoire, installez l'une des étagères au milieu de l'armoire (pour verrouiller la porte). Les deux autres étagères peuvent être installées à l'endroit qui vous convient.

## Armoires supérieures BOÎTE 2 et 3

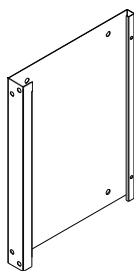

Panneau latéral  
2 pcs.

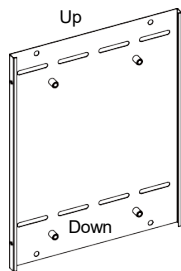

Panneau arrière  
2 pcs.

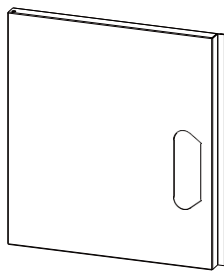

Porte gauche  
1 pc.

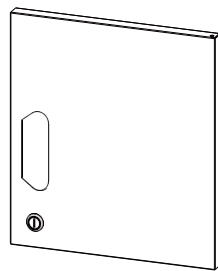

Porte droite 1 pc.

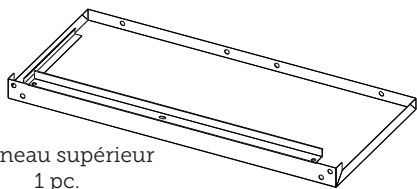

Panneau supérieur  
1 pc.

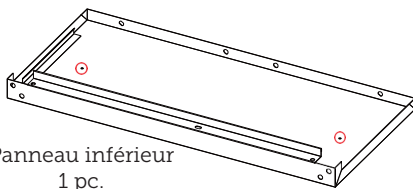

Panneau inférieur  
1 pc.



Installez les armoires supérieures en suivant la même procédure que l'armoire haute. L'armoire supérieure n'a pas d'étagères ni d'anneaux en caoutchouc, veuillez ignorer ces deux éléments.

# Armoire BOÎTE 4

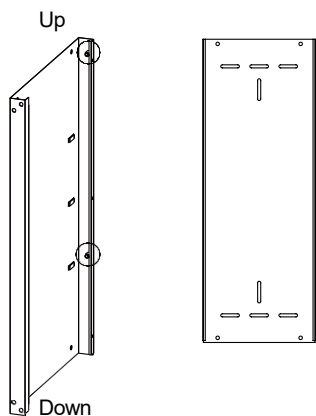

Panneau latéral gauche 1 pc.

Panneau arrière 2 pc.

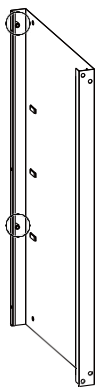

Panneau latéral droit 1 pc.

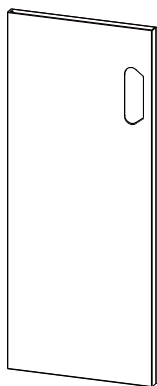

Porte gauche 1 pc.

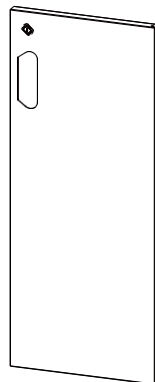

Porte droite 1 pc.

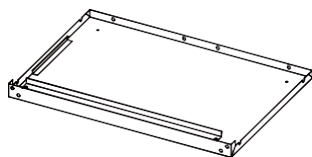

Panneau supérieur 1 pc.

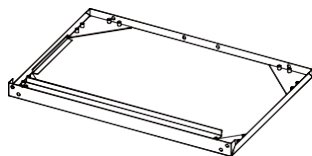

Panneau inférieur 1 pc.

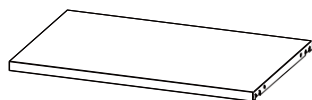

Étagère 1 pcs.



Veillez installer le meuble bas en respectant les instructions de montage du meuble haut.



Aux étapes 2 et 3, le panneau latéral et le panneau arrière sont reliés par des boulons et des écrous.



Écrou M5  
QTÉ : 9 pcs.



Vis M5\*10  
QTÉ : 9 pcs.



Étape 10 : l'étagère peut être ajustée à volonté.

FR

# Trous de connexion

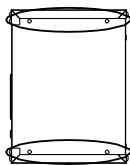
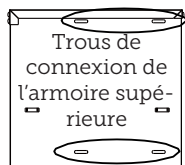

Vue latérale de l'armoire supérieure

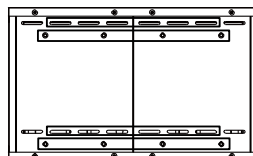

Vue arrière de l'armoire supérieure

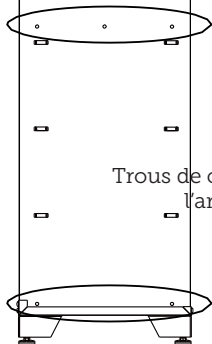

Vue de droite de l'armoire haute

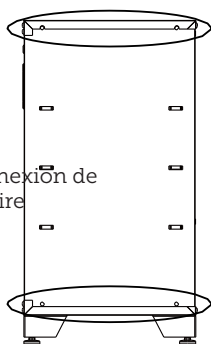

Vue latérale de l'armoire

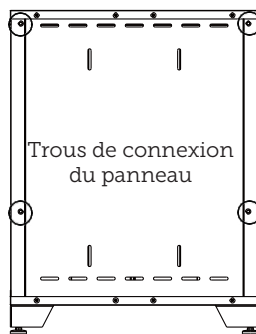

Vue arrière de l'armoire

Trous de connexion du plan de travail

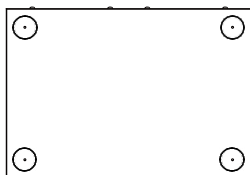

Vue de dessus de l'armoire

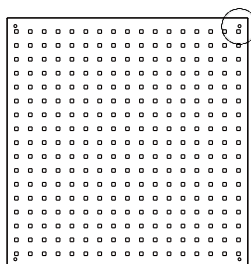

Panneau à outils

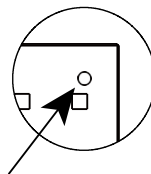

Trou de connexion de l'armoire murale

# Montage au mur

## ÉTAPE 1 :

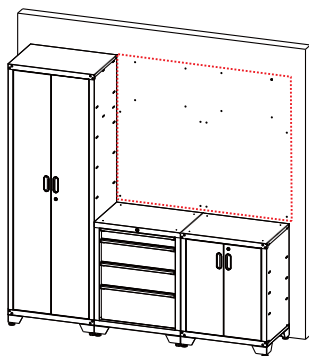

Cheville murale  
QTÉ : 16 pcs.

Planifiez l'emplacement de l'armoire à outils, déterminez la position du trou de connexion entre le panneau à outils et l'armoire supérieure, puis fixez la cheville murale.

Les pieds de l'armoire haute et de l'armoire basse peuvent être relevés, et la position de la cheville murale peut être un peu plus haute.

## ÉTAPE 2 :

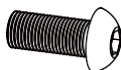

Vis M8\*18  
QTÉ : 8 pcs.



Écrou à bride M8  
QTÉ : 4 pcs.

FR

Placez l'armoire haute et les armoires supérieures dans les positions respectives, alignez-les et connectez-les par paires. Des écrous de rivetage ont été installés sur les panneaux latéraux de l'armoire à tiroirs. Il n'est pas nécessaire d'utiliser les écrous lors du raccordement d'autres armoires.

## ÉTAPE 3 :

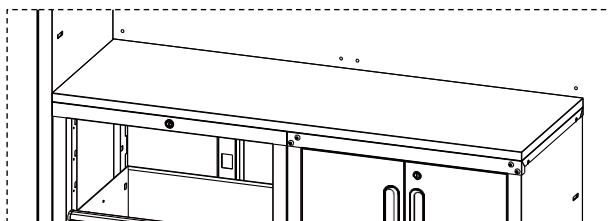

Vis autotaraudeuse  
M5\*15  
QTÉ : 8 pcs.

Installez le plan de travail. Vissez les vis autotaraudeuses dans le plan de travail à travers les trous de montage situés sur le dessus de l'armoire, en vous assurant que le plan de travail est aligné avec l'extérieur de l'armoire basse.

Retirez d'autres tiroirs si nécessaire, et enfin remettez les tiroirs en place.

#### ÉTAPE 4 :

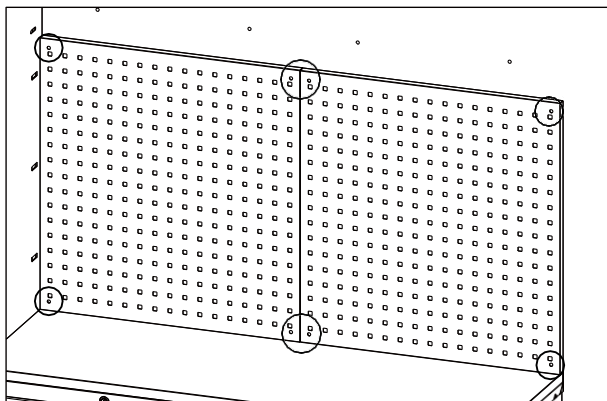

Vis à bois M6\*60  
QTÉ : 8 pcs.



Rondelle métallique Ø22,8  
QTÉ : 8 pcs.

Installez le panneau à outils. Les grandes vis autotaraudeuses doivent passer par les trous ronds situés aux quatre coins du panneau à outils et se visser dans la cheville murale du mur pour fixer le panneau au mur.

#### ÉTAPE 5 :

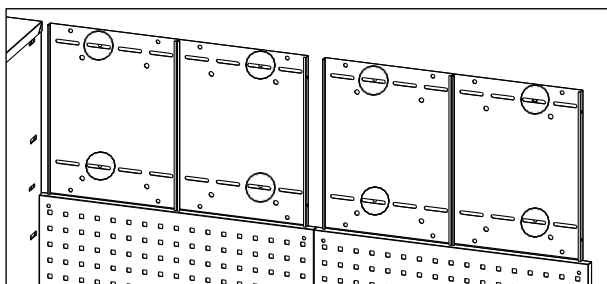

Vis à bois M6\*60  
QTÉ : 8 pcs.



Rondelle métallique Ø22,8  
QTÉ : 8 pcs.

Pour installer l'armoire, vissez la grande vis autotaraudeuse au travers du trou du panneau arrière de l'armoire murale dans la cheville murale pour fixer l'armoire.

#### ÉTAPE 6 :

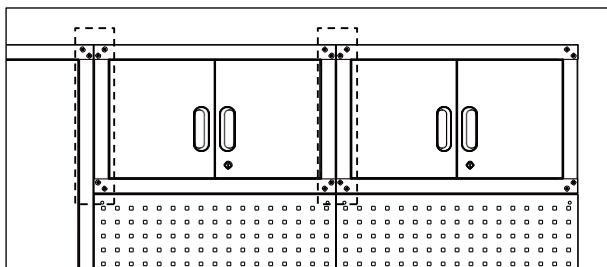

Vis M8\*18  
QTÉ : 8 pcs.



Écrou à bride M8  
QTÉ : 8 pcs.

Des boulons et des écrous sont utilisés entre les armoires supérieures et l'armoire haute.



---

**SERVICE APRÈS-VENTE**

Remarque : veuillez indiquer le numéro de modèle du produit concerné dans toutes vos demandes.

Le numéro de modèle est indiqué sur la première page de ce manuel et sur la plaque signalétique du produit.

*Pour :*

- Les réclamations
- Les pièces de rechange
- Les retours
- Les questions de garantie
- [www.schou.com](http://www.schou.com)

---

Fabriqué en Chine

Fabricant :

Schou Company A/S  
Nordager 31  
DK-6000 Kolding

Tous droits réservés. Le contenu de ce manuel ne peut être reproduit, en tout ou partie, de quelque manière que ce soit par des moyens électroniques ou mécaniques, par exemple par photocopie ou publication, et ne peut être traduit ou sauvegardé dans un système de stockage et de recherche d'informations sans l'autorisation écrite de Schou Company A/S.

---

# **PROBUILDER**

DESIGNED TO WORK